

TOSHIBA

FILE NO. SVM-12004

SERVICE MANUAL

**AIR-CONDITIONER
SPLIT TYPE**

INDOOR UNIT

High Wall Type

***RAV-SM566KRT-E, RAV-SM806KRT-E
RAV-SM566KRT-TR, RAV-SM806KRT-TR***



Adoption of New Refrigerant

This Air Conditioner is a new type which adopts a new refrigerant HFC (R410A) instead of the conventional refrigerant R22 in order to prevent destruction of the ozone layer.

CONTENTS

SAFETY CAUTION	3
1. SPECIFICATIONS	12
1-1. High Wall Type	12
2. CONSTRUCTION VIEWS (EXTERNAL VIEWS)	13
3. SYSTEMATIC REFRIGERATING CYCLE DIAGRAM	15
4. WIRING DIAGRAM	16
5. SPECIFICATIONS OF ELECTRICAL PARTS	17
6. REFRIGERANT R410A	18
6-1. Safety During Installation/Service	18
6-2. Refrigerant Piping Installation	18
6-3. Tools	22
6-4. Recharging of Refrigerant	23
6-5. Brazing of Pipes	24
7. INDOOR CONTROL CIRCUIT	26
7-1. Indoor Controller Block Diagram	26
7-2. Control Specifications	28
7-3. Indoor Print Circuit Board (High Wall Type)	40
8. TROUBLESHOOTING	42
8-1. Summary of Troubleshooting	42
8-2. Troubleshooting	44
9. REPLACEMENT OF SERVICE P.C. BOARD	60
10. SETUP AT LOCAL SITE AND OTHERS	66
11. ADDRESS SETUP	83
11-1. Address Setup Procedure	83
11-2. Address Setup & Group/Twin/Triple Control	84
11-3. Address Setting	86
12. DETACHMENTS	88
13. EXPLODED VIEWS AND PARTS LIST	95
14. APPENDIX (Lite-vision plus remote controller Installation manual)	97

Please read carefully through these instructions that contain important information which complies with the “Machinery” Directive (Directive 2006/42/EC), and ensure that you understand them.

Generic Denomination: Air Conditioner

Definition of Qualified Installer or Qualified Service Person

The air conditioner must be installed, maintained, repaired and removed by a qualified installer or qualified service person. When any of these jobs is to be done, ask a qualified installer or qualified service person to do them for you. A qualified installer or qualified service person is an agent who has the qualifications and knowledge described in the table below.

Agent	Qualifications and knowledge which the agent must have
Qualified installer	<ul style="list-style-type: none"> • The qualified installer is a person who installs, maintains, relocates and removes the air conditioners made by Toshiba Carrier Corporation. He or she has been trained to install, maintain, relocate and remove the air conditioners made by Toshiba Carrier Corporation or, alternatively, he or she has been instructed in such operations by an individual or individuals who have been trained and is thus thoroughly acquainted with the knowledge related to these operations. • The qualified installer who is allowed to do the electrical work involved in installation, relocation and removal has the qualifications pertaining to this electrical work as stipulated by the local laws and regulations, and he or she is a person who has been trained in matters relating to electrical work on the air conditioners made by Toshiba Carrier Corporation or, alternatively, he or she has been instructed in such matters by an individual or individuals who have been trained and is thus thoroughly acquainted with the knowledge related to this work. • The qualified installer who is allowed to do the refrigerant handling and piping work involved in installation, relocation and removal has the qualifications pertaining to this refrigerant handling and piping work as stipulated by the local laws and regulations, and he or she is a person who has been trained in matters relating to refrigerant handling and piping work on the air conditioners made by Toshiba Carrier Corporation or, alternatively, he or she has been instructed in such matters by an individual or individuals who have been trained and is thus thoroughly acquainted with the knowledge related to this work. • The qualified installer who is allowed to work at heights has been trained in matters relating to working at heights with the air conditioners made by Toshiba Carrier Corporation or, alternatively, he or she has been instructed in such matters by an individual or individuals who have been trained and is thus thoroughly acquainted with the knowledge related to this work.
Qualified service person	<ul style="list-style-type: none"> • The qualified service person is a person who installs, repairs, maintains, relocates and removes the air conditioners made by Toshiba Carrier Corporation. He or she has been trained to install, repair, maintain, relocate and remove the air conditioners made by Toshiba Carrier Corporation or, alternatively, he or she has been instructed in such operations by an individual or individuals who have been trained and is thus thoroughly acquainted with the knowledge related to these operations. • The qualified service person who is allowed to do the electrical work involved in installation, repair, relocation and removal has the qualifications pertaining to this electrical work as stipulated by the local laws and regulations, and he or she is a person who has been trained in matters relating to electrical work on the air conditioners made by Toshiba Carrier Corporation or, alternatively, he or she has been instructed in such matters by an individual or individuals who have been trained and is thus thoroughly acquainted with the knowledge related to this work. • The qualified service person who is allowed to do the refrigerant handling and piping work involved in installation, repair, relocation and removal has the qualifications pertaining to this refrigerant handling and piping work as stipulated by the local laws and regulations, and he or she is a person who has been trained in matters relating to refrigerant handling and piping work on the air conditioners made by Toshiba Carrier Corporation or, alternatively, he or she has been instructed in such matters by an individual or individuals who have been trained and is thus thoroughly acquainted with the knowledge related to this work. • The qualified service person who is allowed to work at heights has been trained in matters relating to working at heights with the air conditioners made by Toshiba Carrier Corporation or, alternatively, he or she has been instructed in such matters by an individual or individuals who have been trained and is thus thoroughly acquainted with the knowledge related to this work.

Definition of Protective Gear

When the air conditioner is to be transported, installed, maintained, repaired or removed, wear protective gloves and 'safety' work clothing.



In addition to such normal protective gear, wear the protective gear described below when undertaking the special work detailed in the table below.

Failure to wear the proper protective gear is dangerous because you will be more susceptible to injury, burns, electric shocks and other injuries.

Work undertaken	Protective gear worn
All types of work	Protective gloves 'Safety' working clothing
Electrical-related work	Gloves to provide protection for electricians and from heat Insulating shoes Clothing to provide protection from electric shock
Work done at heights (50 cm or more)	Helmets for use in industry
Transportation of heavy objects	Shoes with additional protective toe cap
Repair of outdoor unit	Gloves to provide protection for electricians and from heat



The important contents concerned to the safety are described on the product itself and on this Service Manual. Please read this Service Manual after understanding the described items thoroughly in the following contents (Indications / Illustrated marks), and keep them.

[Explanation of indications]

Indication	Explanation
 DANGER	Indicates contents assumed that an imminent danger causing a death or serious injury of the repair engineers and the third parties when an incorrect work has been executed.
 WARNING	Indicates possibilities assumed that a danger causing a death or serious injury of the repair engineers, the third parties, and the users due to troubles of the product after work when an incorrect work has been executed.
 CAUTION	Indicates contents assumed that an injury or property damage (*) may be caused on the repair engineers, the third parties, and the users due to troubles of the product after work when an incorrect work has been executed.

* Property damage: Enlarged damage concerned to property, furniture, and domestic animal / pet

[Explanation of illustrated marks]

Mark	Explanation
	Indicates prohibited items (Forbidden items to do) The sentences near an illustrated mark describe the concrete prohibited contents.
	Indicates mandatory items (Compulsory items to do) The sentences near an illustrated mark describe the concrete mandatory contents.
	Indicates cautions (Including danger / warning) The sentences or illustration near or in an illustrated mark describe the concrete cautious contents.

Warning Indications on the Air Conditioner Unit

[Confirmation of warning label on the main unit]

Confirm that labels are indicated on the specified positions



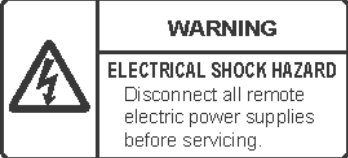
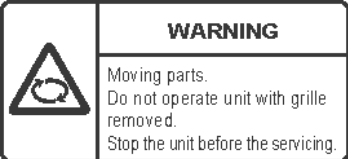
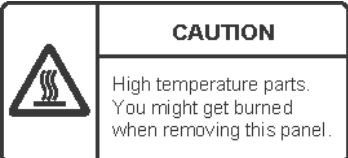
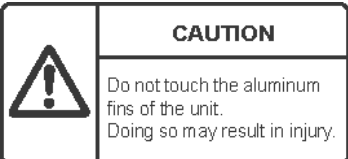
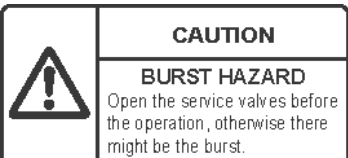

If removing the label during parts replace, stick it as the original.

Warning indication	Description
	<p>WARNING</p> <p>ELECTRICAL SHOCK HAZARD Disconnect all remote electric power supplies before servicing.</p>
	<p>WARNING</p> <p>Moving parts. Do not operate unit with grille removed. Stop the unit before the servicing.</p>
	<p>CAUTION</p> <p>High temperature parts. You might get burned when removing this panel.</p>
	<p>CAUTION</p> <p>Do not touch the aluminium fins of the unit. Doing so may result in injury.</p>
	<p>CAUTION</p> <p>BURST HAZARD Open the service valves before the operation, otherwise there might be the burst.</p>

Precautions for safety







The manufacturer shall not assume any liability for the damage caused by not observing the description of this manual.







DANGER



 Turn off breaker.	<p>Before carrying out the installation, maintenance, repair or removal work, be sure to set the circuit breaker for both the indoor and outdoor units to the OFF position. Otherwise, electric shocks may result.</p> <p>Before opening the front panel of the indoor unit or service panel of the outdoor unit, set the circuit breaker to the OFF position. Failure to set the circuit breaker to the OFF position may result in electric shocks through contact with the interior parts. Only a qualified installer (*1) or qualified service person (*1) is allowed to remove the front panel of the indoor unit or service panel of the outdoor unit and do the work required.</p> <p>Before starting to repair the outdoor unit fan or fan guard, be absolutely sure to set the circuit breaker to the OFF position, and place a "Work in progress" sign on the circuit breaker.</p> <p>When cleaning the filter or other parts of the indoor unit, set the circuit breaker to OFF without fail, and place a "Work in progress" sign near the circuit breaker before proceeding with the work.</p>
 Prohibition	<p>Place a "Work in progress" sign near the circuit breaker while the installation, maintenance, repair or removal work is being carried out. There is a danger of electric shocks if the circuit breaker is set to ON by mistake.</p>
 Stay on protection	<p>If, in the course of carrying out repairs, it becomes absolutely necessary to check out the electrical parts with the electrical control box cover of one or more of the indoor units and the service panel of the outdoor unit removed in order to find out exactly where the trouble lies, wear insulated heat-resistant gloves, insulated boots and insulated work overalls, and take care to avoid touching any live parts. You may receive an electric shock if you fail to heed this warning. Only qualified service person (*1) is allowed to do this kind of work.</p>
 Execute discharge between terminals.	<p>Even if the circuit breaker has been set to the OFF position before the service panel is removed and the electrical parts are repaired, you will still risk receiving an electric shock. For this reason, short-circuit the high-voltage capacitor terminals to discharge the voltage before proceeding with the repair work. For details on the short-circuiting procedure, refer to the Service Manual. You may receive an electric shock if the voltage stored in the capacitors has not been sufficiently discharged.</p>

WARNING

 General	<p>Before starting to repair the air conditioner, read carefully through the Service Manual, and repair the air conditioner by following its instructions.</p>
	<p>Only qualified service person (*1) is allowed to repair the air conditioner. Repair of the air conditioner by unqualified person may give rise to a fire, electric shocks, injury, water leaks and/or other problems.</p>
	<p>Do not use any refrigerant different from the one specified for complement or replacement. Otherwise, abnormally high pressure may be generated in the refrigeration cycle, which may result in a failure or explosion of the product or an injury to your body.</p>
	<p>Only a qualified installer (*1) or qualified service person (*1) is allowed to carry out the electrical work of the air conditioner. Under no circumstances must this work be done by an unqualified individual since failure to carry out the work properly may result in electric shocks and/or electrical leaks.</p>
	<p>When transporting the air conditioner, wear shoes with protective toe caps, protective gloves and other protective clothing.</p>
	<p>Inside the air conditioner are high-voltage areas and rotating parts. Due to the danger of electric shocks or of your fingers or physical objects becoming trapped in the rotating parts, do not remove the front panel of the indoor unit or service panel of the outdoor unit. When work involving the removal of these parts is required, contact a qualified installer(*1) or a qualified service person(*1).</p>
	<p>When connecting the electrical wires, repairing the electrical parts or undertaking other electrical jobs, wear gloves to provide protection for electricians and from heat, insulating shoes and clothing to provide protection from electric shocks. Failure to wear this protective gear may result in electric shocks.</p>
	<p>When checking the electrical parts, removing the cover of the electrical control box of Indoor Unit and/or service panel of Outdoor Unit inevitably to determine the failure, use gloves to provide protection for electricians and from heat, insulating shoes, clothing to provide protection from electric shock and insulating tools. Do not touch the live part. Electric shock may result. Only "Qualified service person (*1)" is allowed to do this work.</p>
	<p>When checking the electrical parts, removing the cover of the electrical control box of Indoor Unit and/or front panel of Outdoor Unit inevitably to determine the failure, put a sign "Do not enter" around the site before the work. Failure to do this may result in third person getting electric shock.</p>
	<p>Electrical wiring work shall be conducted according to law and regulation in the community and installation manual. Failure to do so may result in electrocution or short circuit.</p>
	<p>Only a qualified installer (*1) or qualified service person (*1) is allowed to undertake work at heights using a stand of 50 cm or more or to remove the front panel of the indoor unit to undertake work.</p>
	<p>When working at heights, use a ladder which complies with the ISO 14122 standard, and follow the procedure in the ladder's instructions. Also wear a helmet for use in industry as protective gear to undertake the work.</p>
	<p>When working at heights, put a sign in place so that no-one will approach the work location, before proceeding with the work. Parts and other objects may fall from above, possibly injuring a person below. While carrying out the work, wear a helmet for protection from falling objects.</p>
	<p>Wear protective gloves and safety work clothing during installation, servicing and removal.</p>
	<p>Do not touch the aluminum fin of the outdoor unit. You may injure yourself if you do so. If the fin must be touched for some reason, first put on protective gloves and safety work clothing, and then proceed.</p>
	<p>Do not climb onto or place objects on top of the outdoor unit. You may fall or the objects may fall off of the outdoor unit and result in injury.</p>
	<p>When transporting the air conditioner, wear shoes with additional protective toe caps.</p>
	<p>When transporting the air conditioner, do not take hold of the bands around the packing carton. You may injure yourself if the bands should break.</p>
<p>Use wiring that meets the specifications in the Installation Manual and the stipulations in the local regulations and laws. Use of wiring which does not meet the specifications may give rise to electric shocks, electrical leakage, smoking and/or a fire.</p>	
<p>This air conditioner has passed the pressure test as specified in IEC 60335-2-40 Annex EE.</p>	

 Check earth wires.	<p>Before troubleshooting or repair work, check the earth wire is connected to the earth terminals of the main unit, otherwise an electric shock is caused when a leak occurs. If the earth wire is not correctly connected, contact an electric engineer for rework.</p> <p>After completing the repair or relocation work, check that the ground wires are connected properly.</p> <p>Be sure to connect earth wire. (Grounding work) Incomplete grounding causes an electric shock. Do not connect ground wires to gas pipes, water pipes, and lightning rods or ground wires for telephone wires.</p>
 Prohibition of modification.	<p>Do not modify the products. Do not also disassemble or modify the parts. It may cause a fire, electric shock or injury.</p>
 Use specified parts.	<p>When any of the electrical parts are to be replaced, ensure that the replacement parts satisfy the specifications given in the Service Manual (or use the parts contained on the parts list in the Service Manual). Use of any parts which do not satisfy the required specifications may give rise to electric shocks, smoking and/or a fire.</p>
 Do not bring a child close to the equipment.	<p>If, in the course of carrying out repairs, it becomes absolutely necessary to check out the electrical parts with the electrical control box cover of one or more of the indoor units and the service panel of the outdoor unit removed in order to find out exactly where the trouble lies, put a sign in place so that no-one will approach the work location before proceeding with the work. Third-party individuals may enter the work site and receive electric shocks if this warning is not heeded.</p>
 Insulating measures	<p>Connect the cut-off lead wires with crimp contact, etc., put the closed end side upward and then apply a water-cut method, otherwise a leak or production of fire is caused at the users' side.</p>
 No fire	<p>When performing repairs using a gas burner, replace the refrigerant with nitrogen gas because the oil that coats the pipes may otherwise burn.</p> <p>When repairing the refrigerating cycle, take the following measures.</p> <ol style="list-style-type: none"> 1) Be attentive to fire around the cycle. When using a gas stove, etc., be sure to put out fire before work; otherwise the oil mixed with refrigerant gas may catch fire. 2) Do not use a welder in the closed room. When using it without ventilation, carbon monoxide poisoning may be caused. 3) Do not bring inflammables close to the refrigerant cycle, otherwise fire of the welder may catch the inflammables.
 Refrigerant	<p>The refrigerant used by this air conditioner is the R410A.</p> <p>Check the used refrigerant name and use tools and materials of the parts which match with it. For the products which use R410A refrigerant, the refrigerant name is indicated at a position on the outdoor unit where is easy to see. To prevent miss-charging, the route of the service port is changed from one of the former R22.</p> <p>For an air conditioner which uses R410A, never use other refrigerant than R410A. For an air conditioner which uses other refrigerant (R22, etc.), never use R410A. If different types of refrigerant are mixed, abnormal high pressure generates in the refrigerating cycle and an injury due to breakage may be caused.</p> <p>Do not charge refrigerant additionally. If charging refrigerant additionally when refrigerant gas leaks, the refrigerant composition in the refrigerating cycle changes resulted in change of air conditioner characteristics or refrigerant over the specified standard amount is charged and an abnormal high pressure is applied to the inside of the refrigerating cycle resulted in cause of breakage or injury. Therefore if the refrigerant gas leaks, recover the refrigerant in the air conditioner, execute vacuuming, and then newly recharge the specified amount of liquid refrigerant. In this time, never charge the refrigerant over the specified amount.</p> <p>When recharging the refrigerant in the refrigerating cycle, do not mix the refrigerant or air other than R410A into the specified refrigerant. If air or others is mixed with the refrigerant, abnormal high pressure generates in the refrigerating cycle resulted in cause of injury due to breakage.</p> <p>After installation work, check the refrigerant gas does not leak. If the refrigerant gas leaks in the room, poisonous gas generates when gas touches to fire such as fan heater, stove or cooking stove though the refrigerant gas itself is innocuous.</p> <p>Never recover the refrigerant into the outdoor unit. When the equipment is moved or repaired, be sure to recover the refrigerant with recovering device. The refrigerant cannot be recovered in the outdoor unit; otherwise a serious accident such as breakage or injury is caused.</p>

 Assembly / Wiring	<p>After repair work, surely assemble the disassembled parts, and connect and lead the removed wires as before. Perform the work so that the cabinet or panel does not catch the inner wires.</p> <p>If incorrect assembly or incorrect wire connection was done, a disaster such as a leak or fire is caused at user's side.</p>
 Insulator check	<p>After the work has finished, be sure to use an insulation tester set (500 V Megger) to check the resistance is 1 MΩ or more between the charge section and the non-charge metal section (Earth position).</p> <p>If the resistance value is low, a disaster such as a leak or electric shock is caused at user's side.</p>
 Ventilation	<p>If refrigerant gas has leaked during the installation work, ventilate the room immediately. If the leaked refrigerant gas comes in contact with fire, noxious gas may generate.</p>
 Compulsion	<p>When the refrigerant gas leaks, find up the leaked position and repair it surely.</p> <p>If the leaked position cannot be found up and the repair work is interrupted, pump-down and tighten the service valve, otherwise the refrigerant gas may leak into the room.</p> <p>The poisonous gas generates when gas touches to fire such as fan heater, stove or cooking stove though the refrigerant gas itself is innocuous.</p> <p>When installing equipment which includes a large amount of charged refrigerant such as a multi air conditioner in a sub-room, it is necessary that the density does not the limit even if the refrigerant leaks.</p> <p>If the refrigerant leaks and exceeds the limit density, an accident of shortage of oxygen is caused.</p> <p>Tighten the flare nut with a torque wrench in the specified manner.</p> <p>Excessive tighten of the flare nut may cause a crack in the flare nut after a long period, which may result in refrigerant leakage.</p> <p>Nitrogen gas must be used for the airtight test.</p> <p>The charge hose must be connected in such a way that it is not slack.</p> <p>For the installation / moving / reinstallation work, follow to the Installation Manual.</p> <p>If an incorrect installation is done, a trouble of the refrigerating cycle, water leak, electric shock or fire is caused.</p>
 Check after repair	<p>Before operating the air conditioner after having completed the work, check that the electrical control box cover of the indoor unit and service panel of the outdoor unit are closed, and set the circuit breaker to the ON position. You may receive an electric shock if the power is turned on without first conducting these checks.</p> <p>Once the repair work has been completed, check for refrigerant leaks, and check the insulation resistance and water drainage.</p> <p>Then perform a trial run to check that the air conditioner is running properly.</p> <p>After repair work has finished, check there is no trouble. If check is not executed, a fire, electric shock or injury may be caused. For a check, turn off the power breaker.</p> <p>After repair work (installation of front panel and cabinet) has finished, execute a test run to check there is no generation of smoke or abnormal sound.</p> <p>If check is not executed, a fire or an electric shock is caused. Before test run, install the front panel and cabinet.</p> <p>Be sure to fix the screws back which have been removed for installation or other purposes.</p>
 Do not operate the unit with the valve closed.	<p>Check the following matters before a test run after repairing piping.</p> <ul style="list-style-type: none"> • Connect the pipes surely and there is no leak of refrigerant. • The valve is opened. <p>Running the compressor under condition that the valve closes causes an abnormal high pressure resulted in damage of the parts of the compressor and etc. and moreover if there is leak of refrigerant at connecting section of pipes, the air is sucked and causes further abnormal high pressure resulted in burst or injury.</p>
 Check after reinstallation	<p>Only a qualified installer (*1) or qualified service person (*1) is allowed to relocate the air conditioner. It is dangerous for the air conditioner to be relocated by an unqualified individual since a fire, electric shocks, injury, water leakage, noise and/or vibration may result.</p> <p>Check the following items after reinstallation.</p> <ol style="list-style-type: none"> 1) The earth wire is correctly connected. 2) The power cord is not caught in the product. 3) There is no inclination or unsteadiness and the installation is stable. <p>If check is not executed, a fire, an electric shock or an injury is caused.</p> <p>When carrying out the pump-down work shut down the compressor before disconnecting the refrigerant pipe. Disconnecting the refrigerant pipe with the service valve left open and the compressor still operating will cause air, etc. to be sucked in, raising the pressure inside the refrigeration cycle to an abnormally high level, and possibly resulting in reputing, injury, etc.</p>

 Cooling check	<p>When the service panel of the outdoor unit is to be opened in order for the compressor or the area around this part to be repaired immediately after the air conditioner has been shut down, set the circuit breaker to the OFF position, and then wait at least 10 minutes before opening the service panel.</p> <p>If you fail to heed this warning, you will run the risk of burning yourself because the compressor pipes and other parts will be very hot to the touch. In addition, before proceeding with the repair work, wear the kind of insulated heat-resistant gloves designed to protect electricians.</p> <p>When the service panel of the outdoor unit is to be opened in order for the fan motor, reactor, inverter or the areas around these parts to be repaired immediately after the air conditioner has been shut down, set the circuit breaker to the OFF position, and then wait at least 10 minutes before opening the service panel.</p> <p>If you fail to heed this warning, you will run the risk of burning yourself because the fan motor, reactor, inverter heat sink and other parts will be very hot to the touch.</p> <p>In addition, before proceeding with the repair work, wear the kind of insulated heat-resistant gloves designed to protect electricians.</p>
 Installation	<p>Only a qualified installer (*1) or qualified service person (*1) is allowed to install the air conditioner. If the air conditioner is installed by an unqualified individual, a fire, electric shocks, injury, water leakage, noise and/or vibration may result.</p> <p>Before starting to install the air conditioner, read carefully through the Installation Manual, and follow its instructions to install the air conditioner.</p> <p>Do not install the air conditioner in a location that may be subject to a risk of exposure to a combustible gas. If a combustible gas leaks and becomes concentrated around the unit, a fire may occur.</p> <p>Install the indoor unit at least 2.0 m above the floor level since otherwise the users may injure themselves or receive electric shocks if they poke their fingers or other objects into the indoor unit while the air conditioner is running.</p> <p>Install a circuit breaker that meets the specifications in the installation manual and the stipulations in the local regulations and laws.</p> <p>Install the circuit breaker where it can be easily accessed by the qualified service person (*1).</p> <p>If the unit is installed in a small room, take appropriate measures to prevent the refrigerant from exceeding the limit concentration even if it leaks. Consult the dealer from whom you purchased the air conditioner when you implement the measures. Accumulation of highly concentrated refrigerant may cause an oxygen deficiency accident.</p> <p>Do not place any combustion appliance in a place where it is directly exposed to the wind of air conditioner, otherwise it may cause imperfect combustion.</p>

Explanations given to user

If you have discovered that the fan grille is damaged, do not approach the outdoor unit but set the circuit breaker to the OFF position, and contact a qualified service person to have the repairs done.

Do not set the circuit breaker to the ON position until the repairs are completed.

Relocation

- Only a qualified installer (*1) or qualified service person (*1) is allowed to relocate the air conditioner. It is dangerous for the air conditioner to be relocated by an unqualified individual since a fire, electric shocks, injury, water leakage, noise and/or vibration may result.
- When carrying out the pump-down work shut down the compressor before disconnecting the refrigerant pipe. Disconnecting the refrigerant pipe with the service valve left open and the compressor still operating will cause air, etc. to be sucked in, raising the pressure inside the refrigeration cycle to an abnormally high level, and possibly resulting in rupturing, injury, etc.

(*1) Refer to the "Definition of Qualified Installer or Qualified Service Person"

Declaration of Conformity

Manufacturer: TOSHIBA CARRIER (THAILAND) CO., LTD.
144/9 Moo 5, Bangkadi Industrial Park, Tivanon Road,
Amphur Muang, Pathumthani 12000, Thailand

Authorized Nick Ball

Representative / TCF holder: Toshiba EMEA Engineering Director
Toshiba Carrier UK Ltd.
Porsham Close, Belliver Industrial Estate,
PLYMOUTH, Devon, PL6 7DB.
United Kingdom

Hereby declares that the machinery described below:

Generic Denomination: Air Conditioner

Model / type: RAV-SM566KRT-E, RAV-SM806KRT-E
RAV-SM566KRT-TR, RAV-SM806KRT-TR

Commercial name: Digital Inverter Series / Super Digital Inverter Series Air Conditioner

Complies with the provisions of the "Machinery" Directive (Directive 2006/42/EC) and the regulations transposing into national law.

Complies with the provisions of the following harmonized standard:

EN 378-2: 2008 + A1: 2009

NOTE

This declaration becomes invalid if technical or operational modifications are introduced without the manufacturer's consent.

Specifications

Model	Sound power level (dBA)		Weight (kg) Main unit (Ceiling panel)
	Cooling	Heating	
RAV-SM566KRT-E	*	*	12
RAV-SM806KRT-E	*	*	12
RAV-SM566KRT-TR	*	*	12
RAV-SM806KRT-TR	*	*	12

* Under 70 dBA

1. SPECIFICATIONS

1-1. High-wall type

Model	Indoor unit		RAV-SM	566KRT-E(TR)	806KRT-E(TR)	566KRT-E(TR)	806KRT-E(TR)
	Outdoor unit		RAV-	SP564AT(Z)(ZG)-E	SP804AT(Z)(ZG)-E	SM563AT-E	SM803AT-E
Cooling Capacity			(kW)	5.0	7.1	5.0	6.7
Heating Capacity			(kW)	5.6	8.0	5.6	8.0
Power Supply			1 phase 230V (220-240V) 50Hz				
Electrical Characteristics	Cooling	Running current (A)	6.74-6.18	10.71-9.82	7.77-7.12	11.18-10.25	
		Power consumption (kW)	1.44	2.21	1.66	2.37	
		Power factor (%)	99	96	98	99	
		EER	3.47	3.21	3.01	2.83	
		Energy efficiency class ※	A	A	B	C	
		Energy rating ※※	-	-	-	-	
	Heating	Running current (A)	6.98-6.40	11.02-10.10	7.60-6.96	11.88-10.89	
		Power consumption (kW)	1.50	2.34	1.64	2.49	
		Power factor (%)	99	96	98	99	
		COP	3.73	3.42	3.41	3.21	
		Energy efficiency class ※	A	B	B	C	
		Energy rating ※※	-	-	-	-	
Maximum current (A)		13.4	20.4	12.3	14.4		
Appearance	Main unit		Moon white				
Outer dimension	Main unit	Height (mm)	320	320	320	320	
		Width (mm)	1050	1050	1050	1050	
		Depth (mm)	228	228	228	228	
Total weight	Main unit (kg)		12	12	12	12	
Heat exchanger			Finned tube				
Fan unit	Fan		Cross flow fan				
	Standard air flow	H/M/L (m ³ /min.)	14.0/12.5/11.0	17.0/12.5/11.0	14.0/12.5/11.0	17.0/12.5/11.0	
	Motor (W)		30	30	30	30	
Air filter			Standard filter attached				
Controller (packed with indoor unit)			WH-L11SE				
Controller (sold separately)			RBC-AMT32E,AS21E2,AMS41E,AMS51E				
Sound pressure level		H/M/L (dB·A)	42/39/36	47/41/36	42/39/36	47/41/36	
Sound power level		H/M/L (dB·A)	57/54/51	62/56/51	57/54/51	62/56/51	
Connecting pipe	Gas side (mm)		12.7	15.9	12.7	15.9	
	Liquid side (mm)		6.4	9.5	6.4	9.5	
	Drain port (mm)		VP16				

※IEC Standard ※※AS Standard

2. CONSTRUCTION VIEWS (EXTERNAL VIEWS)

2-1. 4-Way Air Discharge Cassette Type RAV-SM566KRT-E(TR)

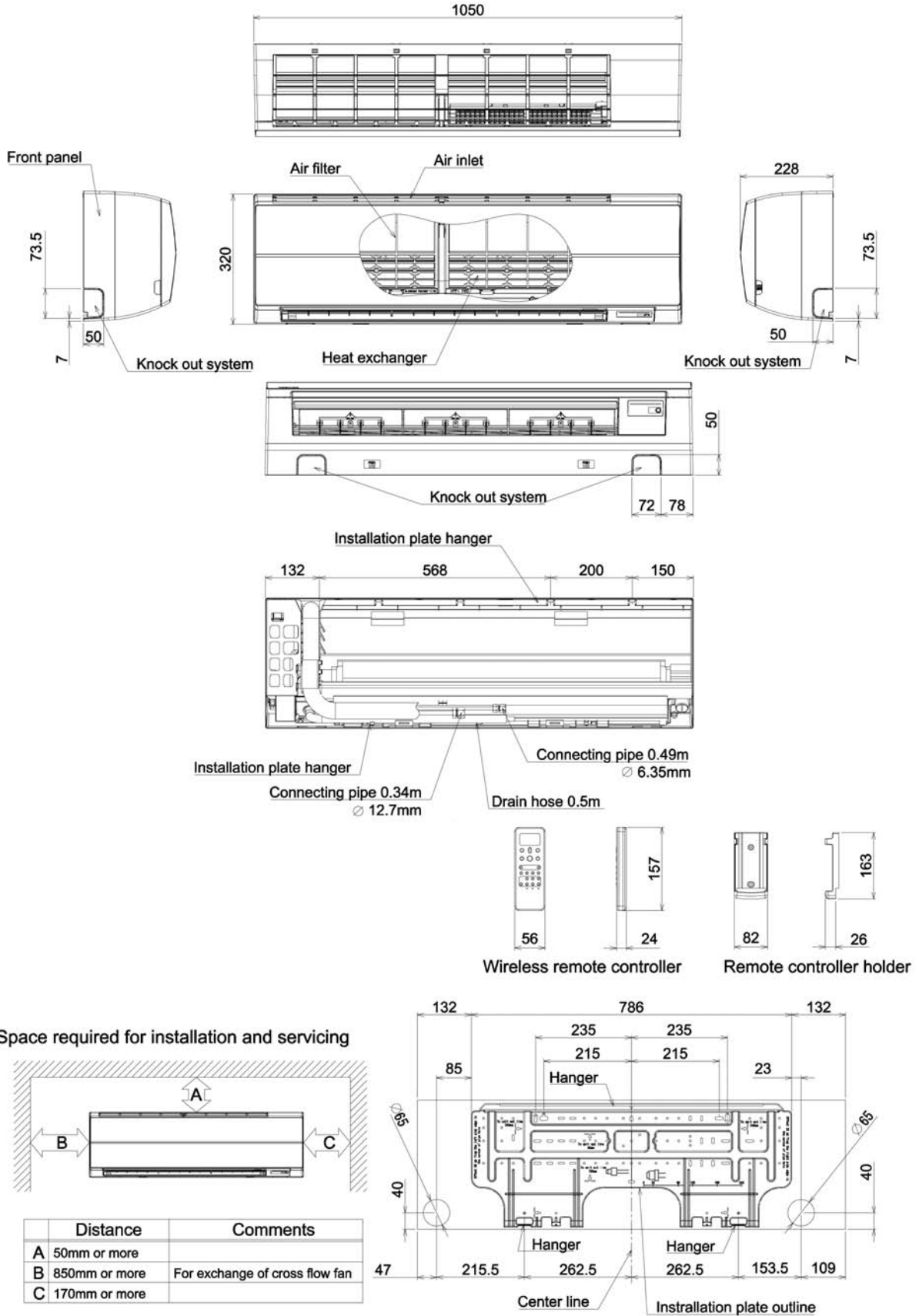

RAV-SM806KRT-E(TR)

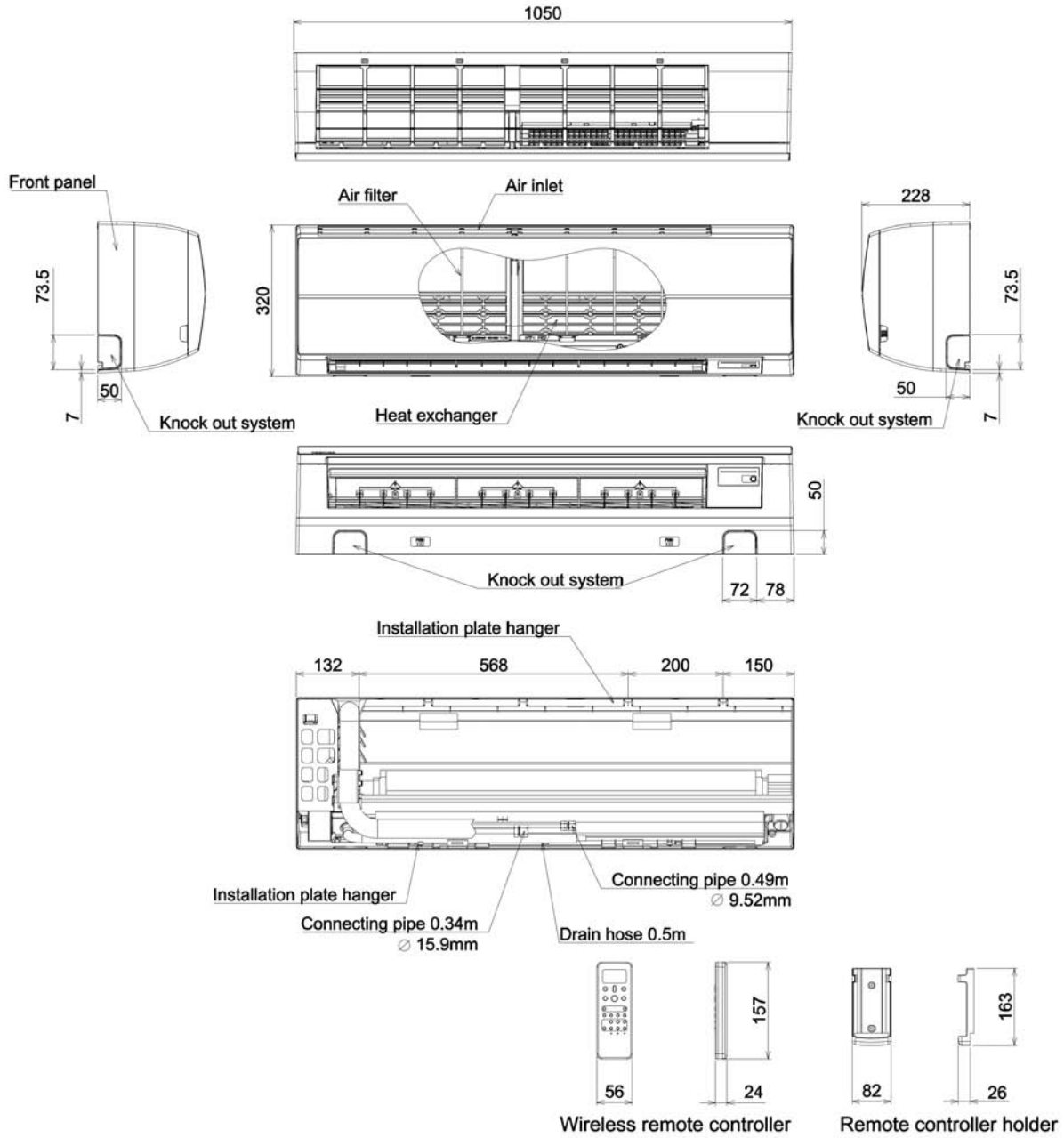

Space required for installation and servicing

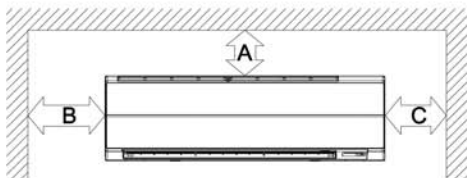

Distance	Comments
A 50mm or more	
B 850mm or more	For exchange of cross flow fan
C 170mm or more	

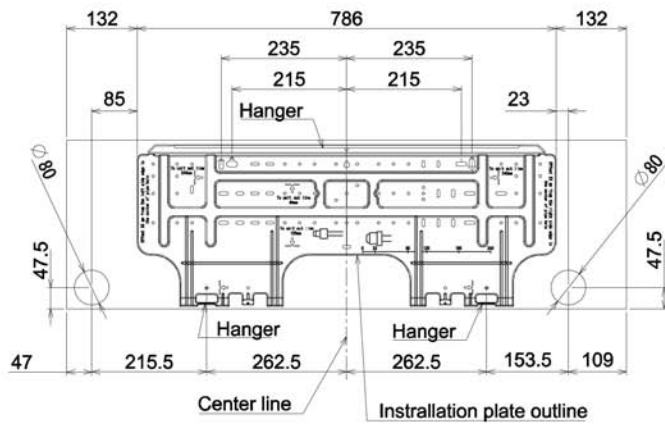

3. SYSTEMATIC REFRIGERATING CYCLE DIAGRAM

High Wall Type

- Single type (Combination of 1 indoor unit and 1 outdoor unit)

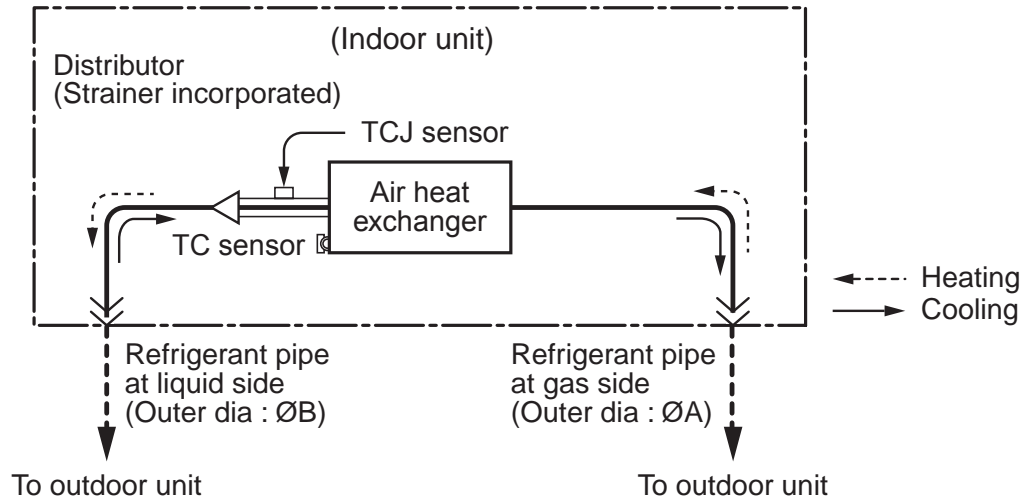

Dimension table

Indoor unit	Outer diameter of refrigerant pipe (In (mm))	
	Gas side ØA	Liquid side ØB
SM56 type	12.7	6.4
SM80 type	15.9	9.5

4. WIRING DIAGRAM

4-1. High Wall Type

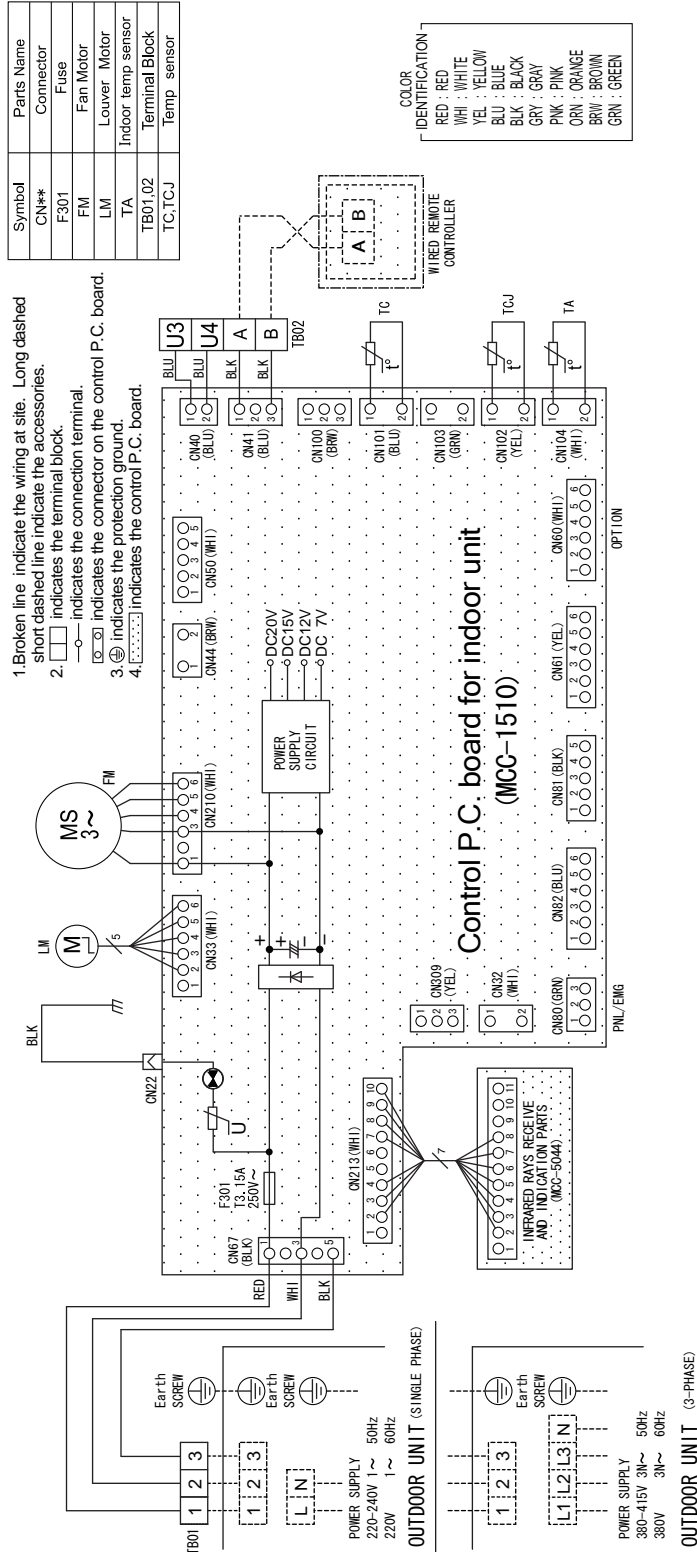

5. SPECIFICATIONS OF ELECTRICAL PARTS

5-3. High Wall Type

No.	Parts Name	Type	Specifications
1	Fan motor (for indoor)	ICF-340-U30-1 ICF-340-30X MF-340-30X	Output (Rated) 30W, 340V DC
2	Grille motor	MP24Z3T	Output (Rated) 1W, 16 poles DC
3	Thermo. Sensor (TA sensor)	318mm	10kΩ at 25°C
4	Heat exchanger sensor (TC sensor)	Ø6,800mm	10kΩ at 25°C
5	Heat exchanger sensor (TCJ sensor)	Ø6,800mm	10kΩ at 25°C

■ Name of Each Part

Air outlet / Louver

Change the direction of the air to be discharged according to cool/heat mode.

Air inlet grille

Air in the room is sucked from here.

Air filter

Removes dirt or dust.
(Provided in the air inlet grille)

Earth screw

Earth screws are provided in the electric parts box.

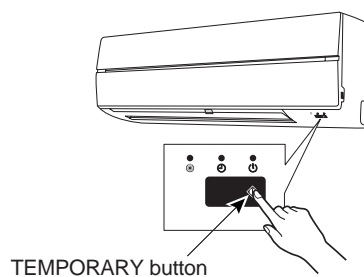

6. REFRIGERANT R410A

This air conditioner adopts the new refrigerant HFC (R410A) which does not damage the ozone layer. The working pressure of the new refrigerant R410A is 1.6 times higher than conventional refrigerant (R22). The refrigerating oil is also changed in accordance with change of refrigerant, so be careful that water, dust, and existing refrigerant or refrigerating oil are not entered in the refrigerant cycle of the air conditioner using the new refrigerant during installation work or servicing time.

The next section describes the precautions for air conditioner using the new refrigerant.

Conforming to contents of the next section together with the general cautions included in this manual, perform the correct and safe work.

6-1. Safety During Installation/Serviceing

As R410A's pressure is about 1.6 times higher than that of R22, improper installation/servicing may cause a serious trouble. By using tools and materials exclusive for R410A, it is necessary to carry out installation/servicing safely while taking the following precautions into consideration.

1. Never use refrigerant other than R410A in an air conditioner which is designed to operate with R410A. If other refrigerant than R410A is mixed, pressure in the refrigeration cycle becomes abnormally high, and it may cause personal injury, etc. by a rupture.
2. Confirm the used refrigerant name, and use tools and materials exclusive for the refrigerant R410A. The refrigerant name R410A is indicated on the visible place of the outdoor unit of the air conditioner using R410A as refrigerant.
To prevent mischarging, the diameter of the service port differs from that of R22.
3. If a refrigeration gas leakage occurs during installation/servicing, be sure to ventilate fully.
If the refrigerant gas comes into contact with fire, a poisonous gas may occur.
4. When installing or removing an air conditioner, do not allow air or moisture to remain in the refrigeration cycle.
Otherwise, pressure in the refrigeration cycle may become abnormally high so that a rupture or personal injury may be caused.
5. After completion of installation work, check to make sure that there is no refrigeration gas leakage. If the refrigerant gas leaks into the room, coming into contact with fire in the fan-driven heater, space heater, etc., a poisonous gas may occur.

6. When an air conditioning system charged with a large volume of refrigerant is installed in a small room, it is necessary to exercise care so that, even when refrigerant leaks, its concentration does not exceed the marginal level.

If the refrigerant gas leakage occurs and its concentration exceeds the marginal level, an oxygen starvation accident may result.

7. Be sure to carry out installation or removal according to the installation manual.
Improper installation may cause refrigeration trouble, water leakage, electric shock, fire, etc.
8. Unauthorized modifications to the air conditioner may be dangerous.
If a breakdown occurs please call a qualified air conditioner technician or electrician.
Improper repair may result in water leakage, electric shock and fire, etc.

6-2. Refrigerant Piping Installation

6-2-1. Piping Materials and Joints Used

For the refrigerant piping installation, copper pipes and joints are mainly used. Copper pipes and joints suitable for the refrigerant must be chosen and installed. Furthermore, it is necessary to use clean copper pipes and joints whose interior surfaces are less affected by contaminants.

1. Copper Pipes

It is necessary to use seamless copper pipes which are made of either copper or copper alloy and it is desirable that the amount of residual oil is less than 40 mg/10 m.

Do not use copper pipes having a collapsed, deformed or discolored portion (especially on the interior surface).

Otherwise, the expansion valve or capillary tube may become blocked with contaminants.

As an air conditioner using R410A incurs pressure higher than when using R22, it is necessary to choose adequate materials.

Thicknesses of copper pipes used with R410A are as shown in Table 6-2-1.

Never use copper pipes thinner than 0.8 mm even when it is available on the market.

Table 6-2-1 Thicknesses of annealed copper pipes

		Thickness (mm)	
Nominal diameter	Outer diameter (mm)	R410A	R22
1/4	6.35	0.80	0.80
3/8	9.52	0.80	0.80
1/2	12.70	0.80	0.80
5/8	15.88	1.00	1.00

2. Joints

For copper pipes, flare joints or socket joints are used. Prior to use, be sure to remove all contaminants.

a) Flare Joints

Flare joints used to connect the copper pipes cannot be used for pipings whose outer diameter exceeds 20 mm. In such a case, socket joints can be used.

Sizes of flare pipe ends, flare joint ends and flare nuts are as shown in Tables 6-2-3 to 6-2-6 below.

b) Socket Joints

Socket joints are such that they are brazed for connections, and used mainly for thick pipings whose diameter is larger than 20 mm.

Thicknesses of socket joints are as shown in Table 6-2-2.

Table 6-2-2 Minimum thicknesses of socket joints

Nominal diameter	Reference outer diameter of copper pipe jointed (mm)	Minimum joint thickness (mm)
1/4	6.35	0.50
3/8	9.52	0.60
1/2	12.70	0.70
5/8	15.88	0.80

6-2-2. Processing of Piping Materials

When performing the refrigerant piping installation, care should be taken to ensure that water or dust does not enter the pipe interior, that no other oil than lubricating oils used in the installed air-water heat pump is used, and that refrigerant does not leak.

When using lubricating oils in the piping processing, use such lubricating oils whose water content has been removed. When stored, be sure to seal the container with an airtight cap or any other cover.

1. Flare processing procedures and precautions

a) Cutting the Pipe

By means of a pipe cutter, slowly cut the pipe so that it is not deformed.

b) Removing Burrs and Chips

If the flared section has chips or burrs, refrigerant leakage may occur.

Carefully remove all burrs and clean the cut surface before installation.

c) Insertion of Flare Nut

d) Flare Processing

Make certain that a clamp bar and copper pipe have been cleaned.

By means of the clamp bar, perform the flare processing correctly.

Use either a flare tool for R410A or conventional flare tool.

Flare processing dimensions differ according to the type of flare tool.

When using a conventional flare tool, be sure to secure "dimension A" by using a gauge for size adjustment.

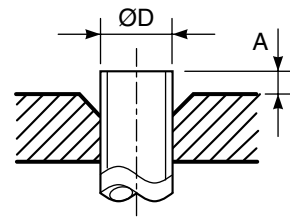

Fig. 6-2-1 Flare processing dimensions

Table 6-2-3 Dimensions related to flare processing for R410A

Nominal diameter	Outer diameter (mm)	Thickness (mm)	A (mm)		
			Flare tool for R410A clutch type	Conventional flare tool	
				Clutch type	Wing nut type
1/4	6.35	0.8	0 to 0.5	1.0 to 1.5	1.5 to 2.0
3/8	9.52	0.8	0 to 0.5	1.0 to 1.5	1.5 to 2.0
1/2	12.70	0.8	0 to 0.5	1.0 to 1.5	2.0 to 2.5
5/8	15.88	1.0	0 to 0.5	1.0 to 1.5	2.0 to 2.5

Table 6-2-4 Dimensions related to flare processing for R22

Nominal diameter	Outer diameter (mm)	Thickness (mm)	A (mm)		
			Flare tool for R22 clutch type	Conventional flare tool	
				Clutch type	Wing nut type
1/4	6.35	0.8	0 to 0.5	0.5 to 1.0	1.0 to 1.5
3/8	9.52	0.8	0 to 0.5	0.5 to 1.0	1.0 to 1.5
1/2	12.70	0.8	0 to 0.5	0.5 to 1.0	1.5 to 2.0
5/8	15.88	1.0	0 to 0.5	0.5 to 1.0	1.5 to 2.0

Table 6-2-5 Flare and flare nut dimensions for R410A

Nominal diameter	Outer diameter (mm)	Thickness (mm)	Dimension (mm)				Flare nut width (mm)
			A	B	C	D	
1/4	6.35	0.8	9.1	9.2	6.5	13	17
3/8	9.52	0.8	13.2	13.5	9.7	20	22
1/2	12.70	0.8	16.6	16.0	12.9	23	26
5/8	15.88	1.0	19.7	19.0	16.0	25	29

Table 6-2-6 Flare and flare nut dimensions for R22

Nominal diameter	Outer diameter (mm)	Thickness (mm)	Dimension (mm)				Flare nut width (mm)
			A	B	C	D	
1/4	6.35	0.8	9.0	9.2	6.5	13	17
3/8	9.52	0.8	13.0	13.5	9.7	20	22
1/2	12.70	0.8	16.2	16.0	12.9	20	24
5/8	15.88	1.0	19.7	19.0	16.0	23	27
3/4	19.05	1.0	23.3	24.0	19.2	34	36

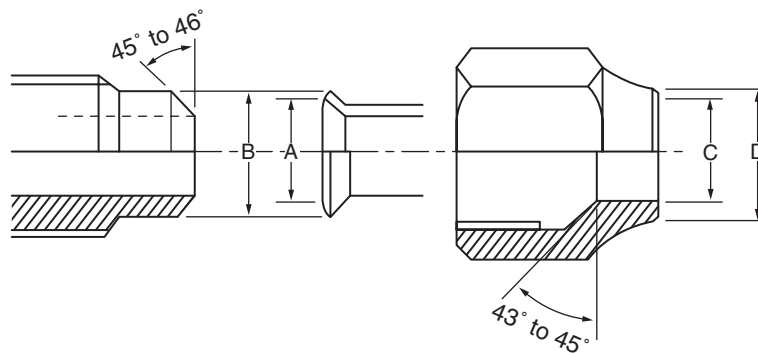

Fig. 6-2-2 Relations between flare nut and flare seal surface

2. Flare Connecting Procedures and Precautions

- a) Make sure that the flare and union portions do not have any scar or dust, etc.
- b) Correctly align the processed flare surface with the union axis.
- c) Tighten the flare with designated torque by means of a torque wrench.

The tightening torque for R410A is the same as that for conventional R22.

Incidentally, when the torque is weak, the gas leakage may occur.

When it is strong, the flare nut may crack and may be made non-removable. When choosing the tightening torque, comply with values designated by manufacturers. Table 6-2-7 shows reference values.

NOTE :

When applying oil to the flare surface, be sure to use oil designated by the manufacturer.

If any other oil is used, the lubricating oils may deteriorate and cause the compressor to burn out.

Table 6-2-7 Tightening torque of flare for R410A [Reference values]

Nominal diameter	Outer diameter (mm)	Tightening torque N·m (kgf·cm)	Tightening torque of torque wrenches available on the market N·m (kgf·cm)
1/4	6.35	14 to 18 (140 to 180)	16 (160), 18 (180)
3/8	9.52	33 to 42 (330 to 420)	42 (420)
1/2	12.70	50 to 62 (500 to 620)	55 (550)
5/8	15.88	63 to 77 (630 to 770)	65 (650)

6-3. Tools

6-3-1. Required Tools

The service port diameter of packed valve of the outdoor unit in the air-water heat pump using R410A is changed to prevent mixing of other refrigerant.

To reinforce the pressure-resisting strength, flare processing dimensions and opposite side dimension of flare nut (For Ø12.7 copper pipe) of the refrigerant piping are lengthened.

The used refrigerating oil is changed, and mixing of oil may cause a trouble such as generation of sludge, clogging of capillary, etc. Accordingly, the tools to be used are classified into the following three types.

1. Tools exclusive for R410A (Those which cannot be used for conventional refrigerant (R22))
2. Tools exclusive for R410A, but can be also used for conventional refrigerant (R22)
3. Tools commonly used for R410A and for conventional refrigerant (R22)

The table below shows the tools exclusive for R410A and their interchangeability.

Tools exclusive for R410A (The following tools for R410A are required.)

Tools whose specifications are changed for R410A and their interchangeability

No.	Used tool	Usage	R410A air-water heat pump installation		Conventional air-water heat pump installation
			Existence of new equipment for R410A	Whether conventional equipment can be used	Whether new equipment can be used with conventional refrigerant
1	Flare tool	Pipe flaring	Yes	* (Note 1)	○
2	Copper pipe gauge for adjusting projection margin	Flaring by conventional flare tool	Yes	* (Note 1)	* (Note 1)
3	Torque wrench	Connection of flare nut	Yes	×	×
4	Gauge manifold	Evacuating, refrigerant charge, run check, etc.	Yes	×	×
5	Charge hose				
6	Vacuum pump adapter	Vacuum evacuating	Yes	×	○
7	Electronic balance for refrigerant charging	Refrigerant charge	Yes	×	○
8	Refrigerant cylinder	Refrigerant charge	Yes	×	×
9	Leakage detector	Gas leakage check	Yes	×	○
10	Charging cylinder	Refrigerant charge	(Note 2)	×	×

(Note 1) When flaring is carried out for R410A using the conventional flare tools, adjustment of projection margin is necessary. For this adjustment, a copper pipe gauge, etc. are necessary.

(Note 2) Charging cylinder for R410A is being currently developed.

General tools (Conventional tools can be used.)

In addition to the above exclusive tools, the following equipments which serve also for R22 are necessary as the general tools.

- | | |
|--|---|
| <ol style="list-style-type: none"> 1) Vacuum pump
Use vacuum pump by attaching vacuum pump adapter. 2) Torque wrench 3) Pipe cutter 4) Reamer 5) Pipe bender 6) Level vial | <ol style="list-style-type: none"> 7) Screwdriver (+, -) 8) Spanner or Monkey wrench 9) Hole core drill (Ø65) 10) Hexagon wrench (Opposite side 4mm) 11) Tape measure 12) Metal saw |
|--|---|

Also prepare the following equipments for other installation method and run check.

- | | |
|--|---|
| <ol style="list-style-type: none"> 1) Clamp meter 2) Thermometer | <ol style="list-style-type: none"> 3) Insulation resistance tester 4) Electroscop |
|--|---|

6-4. Recharging of Refrigerant

When it is necessary to recharge refrigerant, charge the specified amount of new refrigerant according to the following steps.

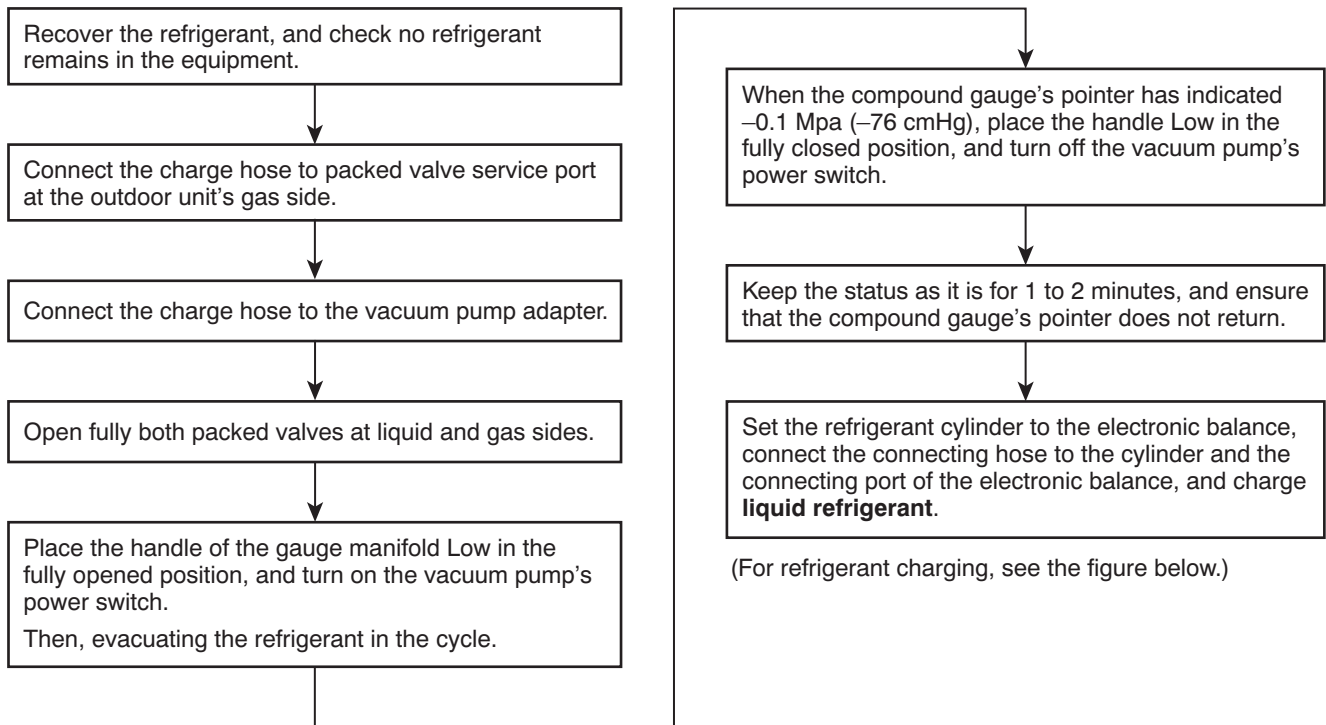

⚠ CAUTION

1. Never charge refrigerant exceeding the specified amount.
2. If the specified amount of refrigerant cannot be charged, charge refrigerant **bit by bit** in COOL mode.
3. Do not carry out additional charging.

When additional charging is carried out if refrigerant leaks, the refrigerant composition changes in the refrigeration cycle, that is characteristics of the air conditioner changes, refrigerant exceeding the specified amount is charged, and working pressure in the refrigeration cycle becomes abnormally high pressure, and may cause a rupture or personal injury.

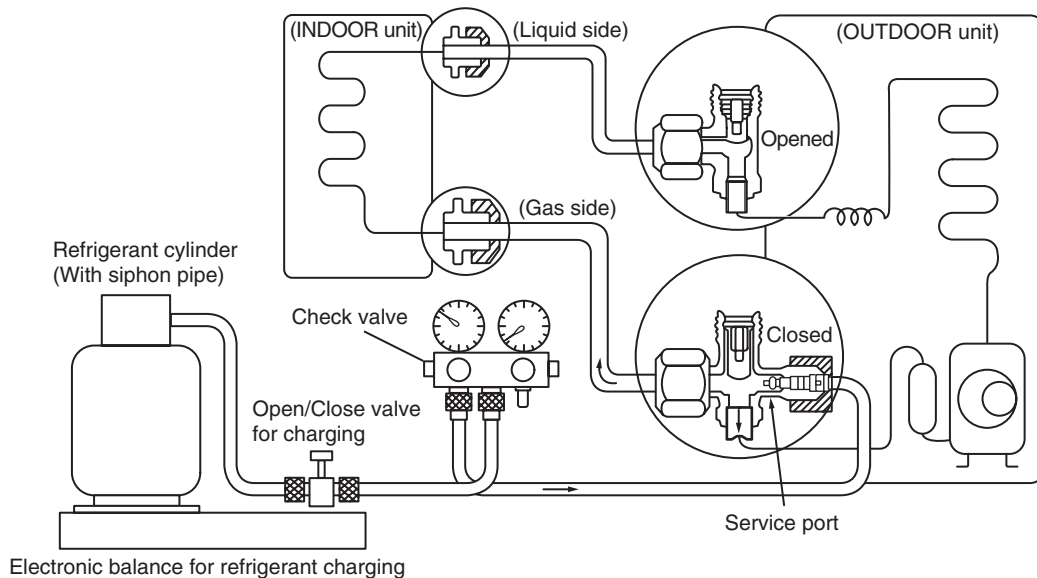
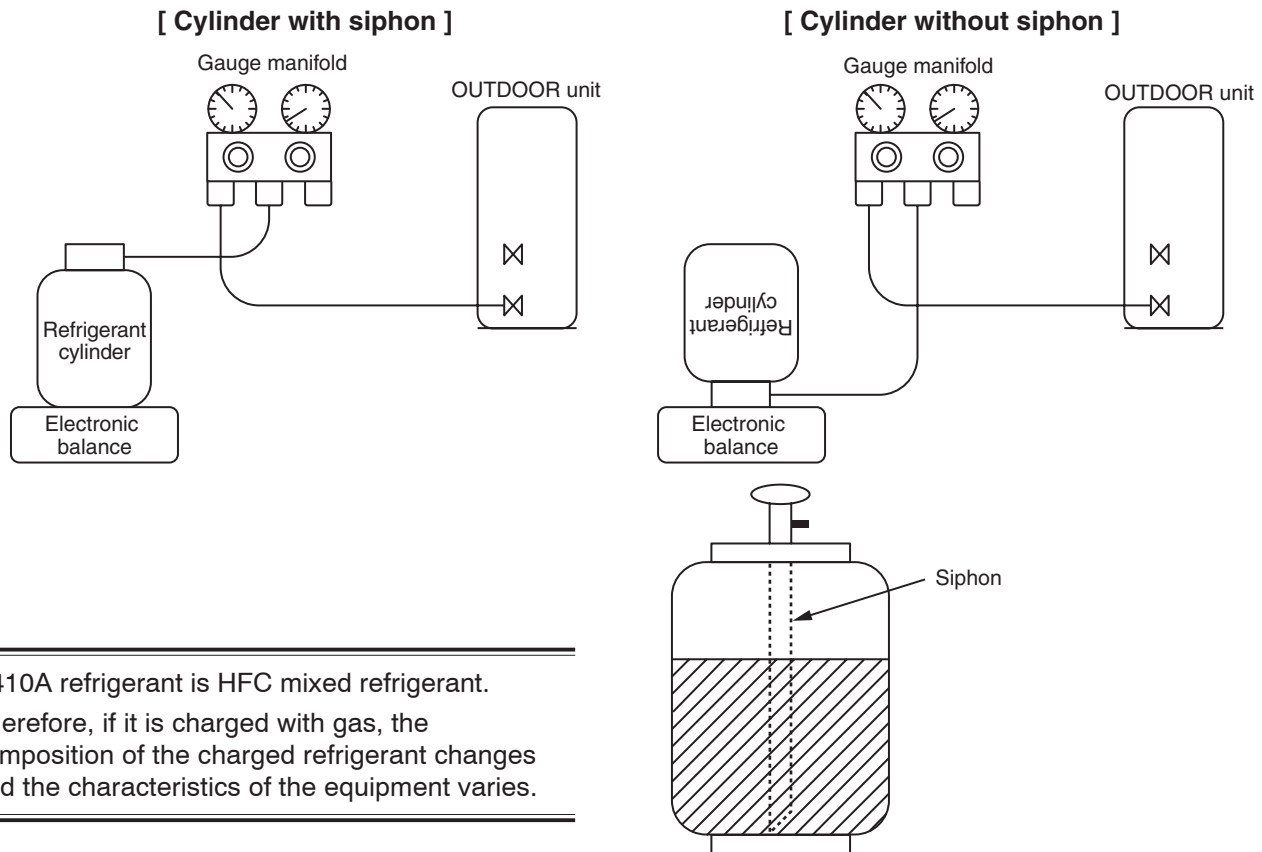

Fig. 6-4-1 Configuration of refrigerant charging

1. Be sure to make setting so that **liquid** can be charged.
2. When using a cylinder equipped with a siphon, liquid can be charged without turning it upside down.

It is necessary for charging refrigerant under condition of liquid because R410A is mixed type of refrigerant. Accordingly, when charging refrigerant from the refrigerant cylinder to the equipment, charge it turning the cylinder upside down if cylinder is not equipped with siphon.



R410A refrigerant is HFC mixed refrigerant. Therefore, if it is charged with gas, the composition of the charged refrigerant changes and the characteristics of the equipment varies.

Fig. 6-4-2

6-5. Brazing of Pipes

6-5-1. Materials for Brazing

1. Silver brazing filler

Silver brazing filler is an alloy mainly composed of silver and copper.

It is used to join iron, copper or copper alloy, and is relatively expensive though it excels in solderability.

2. Phosphor bronze brazing filler

Phosphor bronze brazing filler is generally used to join copper or copper alloy.

3. Low temperature brazing filler

Low temperature brazing filler is generally called solder, and is an alloy of tin and lead. Since it is weak in adhesive strength, do not use it for refrigerant pipes.

1. Phosphor bronze brazing filler tends to react with sulfur and produce a fragile compound water solution, which may cause a gas leakage.

Therefore, use any other type of brazing filler at a hot spring resort, etc., and coat the surface with a paint.

2. When performing brazing again at time of servicing, use the same type of brazing filler.

6-5-2. Flux

1. Reason why flux is necessary

- By removing the oxide film and any foreign matter on the metal surface, it assists the flow of brazing filler.
- In the brazing process, it prevents the metal surface from being oxidized.
- By reducing the brazing filler's surface tension, the brazing filler adheres better to the treated metal.

2. Characteristics required for flux

- Activated temperature of flux coincides with the brazing temperature.
- Due to a wide effective temperature range, flux is hard to carbonize.
- It is easy to remove slag after brazing.
- The corrosive action to the treated metal and brazing filler is minimum.
- It excels in coating performance and is harmless to the human body.

As the flux works in a complicated manner as described above, it is necessary to select an adequate type of flux according to the type and shape of treated metal, type of brazing filler and brazing method, etc.

3. Types of flux

• **Noncorrosive flux**

Generally, it is a compound of borax and boric acid. It is effective in case where the brazing temperature is higher than 800°C.

• **Activated flux**

Most of fluxes generally used for silver brazing are this type. It features an increased oxide film removing capability due to the addition of compounds such as potassium fluoride, potassium chloride and sodium fluoride to the borax-boric acid compound.

4. Piping materials for brazing and used brazing filler/flux

Piping material	Used brazing filler	Used flux
Copper - Copper	Phosphor copper	Do not use
Copper - Iron	Silver	Paste flux
Iron - Iron	Silver	Vapor flux

1. Do not enter flux into the refrigeration cycle.
2. When chlorine contained in the flux remains within the pipe, the lubricating oil deteriorates. Therefore, use a flux which does not contain chlorine.
3. When adding water to the flux, use water which does not contain chlorine (e.g. distilled water or ion-exchange water).
4. Remove the flux after brazing.

6-5-3. Brazing

As brazing work requires sophisticated techniques, experiences based upon a theoretical knowledge, it must be performed by a person qualified.

In order to prevent the oxide film from occurring in the pipe interior during brazing, it is effective to proceed with brazing while letting dry Nitrogen gas (N₂) flow.

Never use gas other than Nitrogen gas.

1. Brazing method to prevent oxidation

- 1) Attach a reducing valve and a flow-meter to the Nitrogen gas cylinder.
- 2) Use a copper pipe to direct the piping material, and attach a flow-meter to the cylinder.
- 3) Apply a seal onto the clearance between the piping material and inserted copper pipe for Nitrogen in order to prevent backflow of the Nitrogen gas.
- 4) When the Nitrogen gas is flowing, be sure to keep the piping end open.
- 5) Adjust the flow rate of Nitrogen gas so that it is lower than 0.05 m³/Hr or 0.02 MPa (0.2kgf/cm²) by means of the reducing valve.
- 6) After performing the steps above, keep the Nitrogen gas flowing until the pipe cools down to a certain extent (temperature at which pipes are touchable with hands).
- 7) Remove the flux completely after brazing.

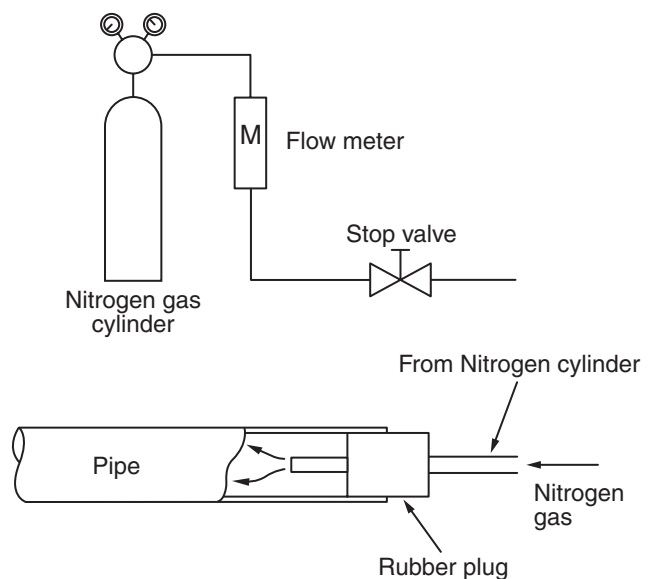
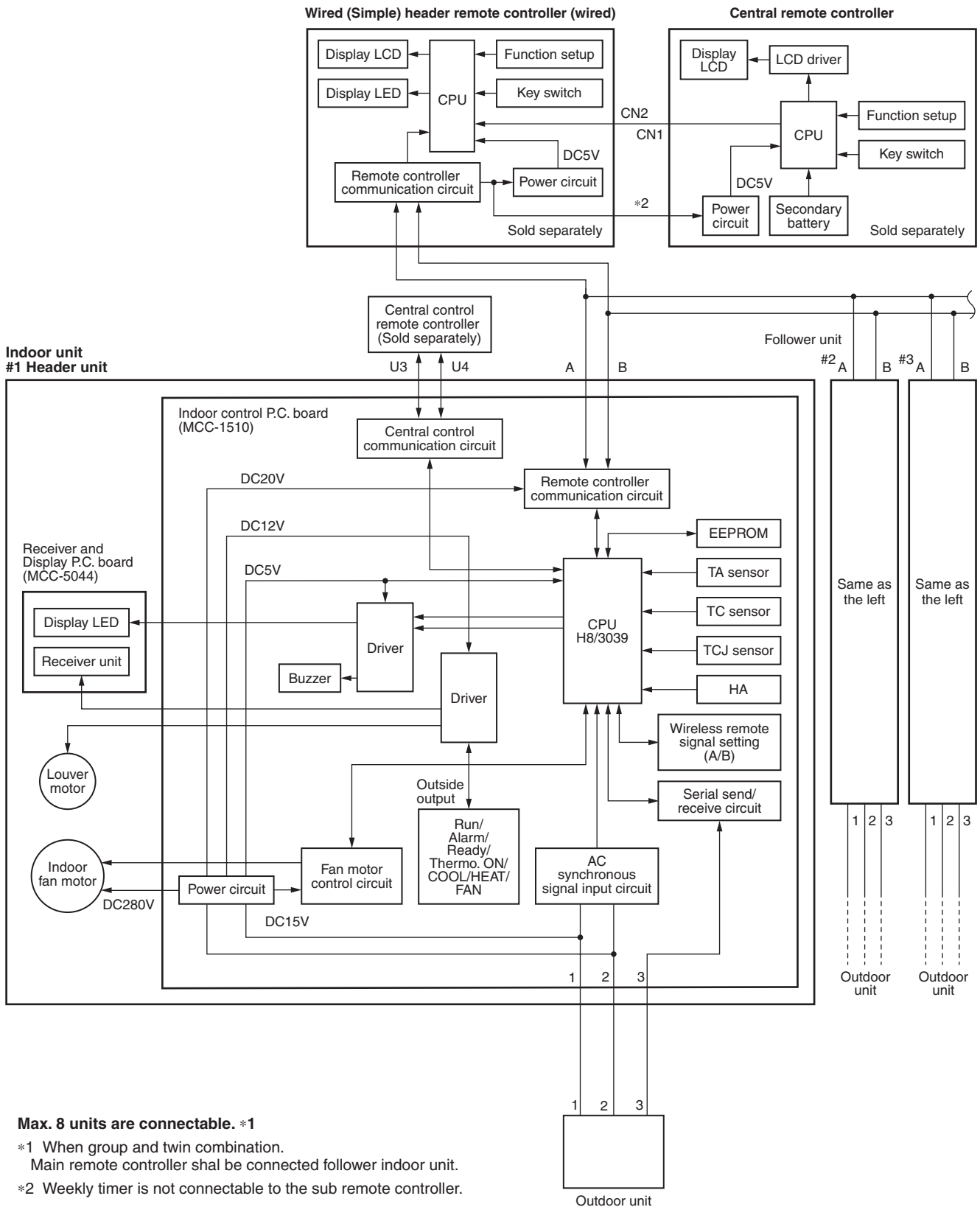

Fig. 6-5-1 Prevention of oxidation during brazing

7. INDOOR UNIT CONTROL

7-1. Indoor Controller block diagram

7-1-1. Connection of wired remote controller



Max. 8 units are connectable. *1

*1 When group and twin combination.
Main remote controller shall be connected follower indoor unit.

*2 Weekly timer is not connectable to the sub remote controller.

7-1-2. Connection of Wireless Remote Controller

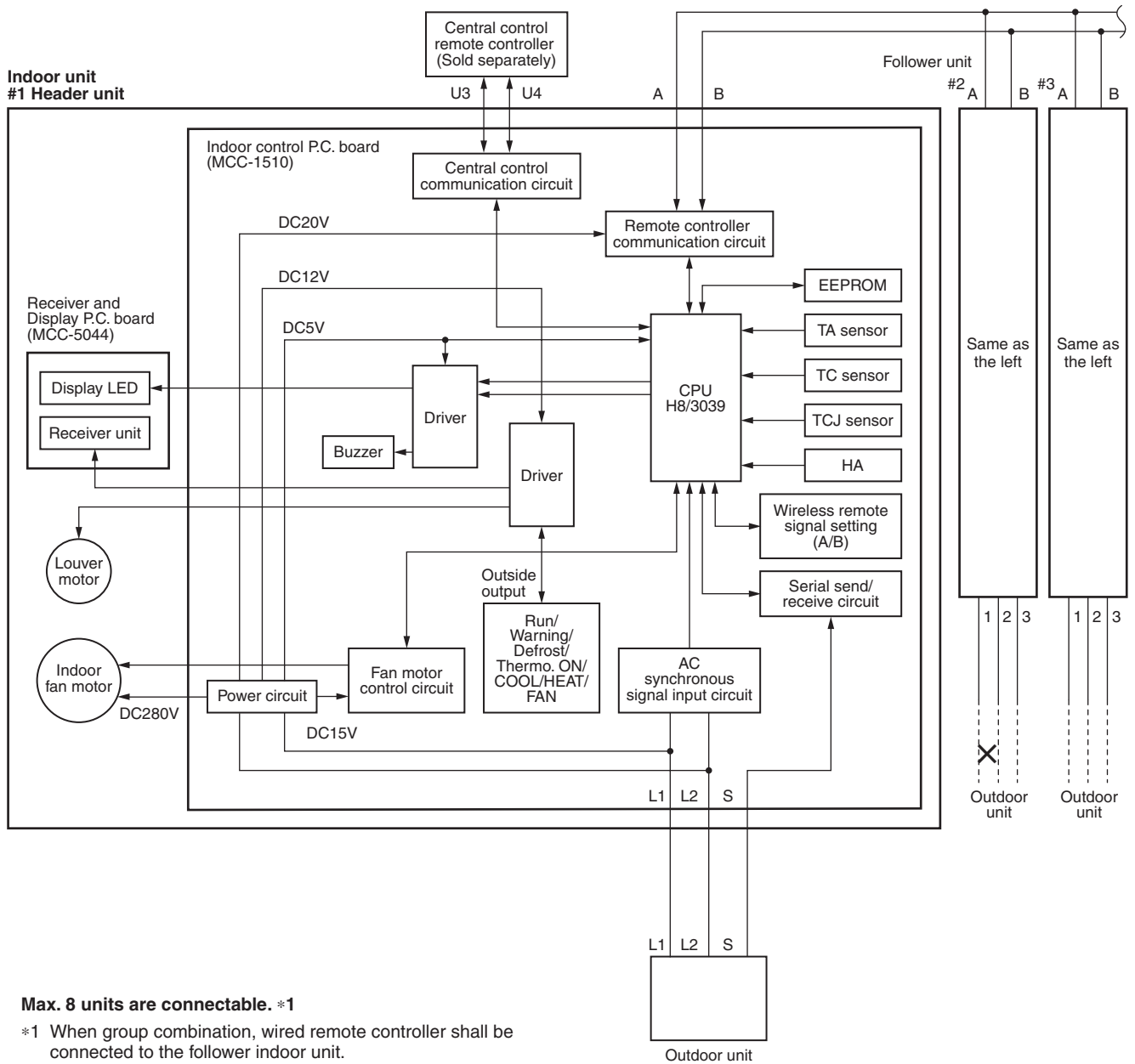



7-2. Control Specifications (High Wall Type)

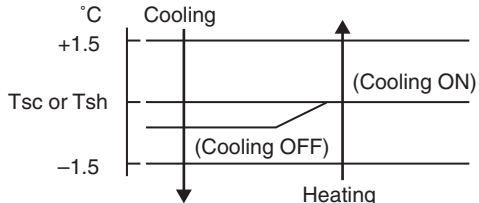



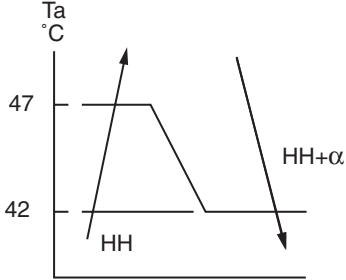

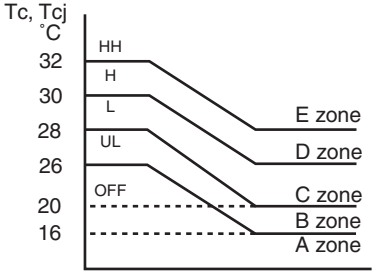

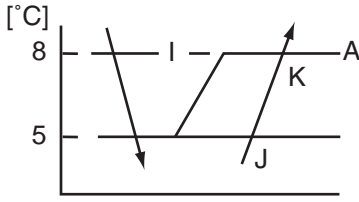
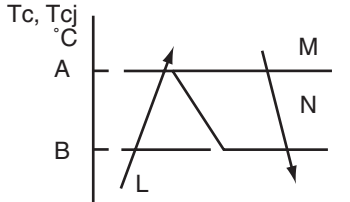
No.	Item	Outline of specifications	Remarks																										
1	When power supply is reset	<p>1) Distinction of outdoor unit When the power supply is reset, the outdoors are distinguished and the control is selected according to the distinguished result.</p> <p>2) Setting of indoor fan speed and existence of air direction adjustment Based on EEPROM data, select setting of the indoor fan speed and the existence of air direction adjustment.</p>	Fan speed (rpm)/ Air direction adjustment																										
2	Operation mode selection	<p>1) Based on the operation mode selecting command from the remote controller, the operation mode is selected.</p> <table border="1" style="margin-left: 20px;"> <thead> <tr> <th>Remote controller command</th> <th>Control outline</th> </tr> </thead> <tbody> <tr> <td>STOP</td> <td>Air conditioner stops.</td> </tr> <tr> <td>FAN</td> <td>Fan operation</td> </tr> <tr> <td>COOL</td> <td>Cooling operation</td> </tr> <tr> <td>DRY</td> <td>Dry operation</td> </tr> <tr> <td>HEAT</td> <td>Heating operation</td> </tr> <tr> <td>AUTO</td> <td> <ul style="list-style-type: none"> COOL/HEAT operation mode is automatically selected by Ta, Ts and To for operation. The operation is performed as shown in the following figure according to Ta value at the first time only. (In the range of $T_s + \alpha - 1 < T_a < T_s + \alpha + 1$, Cooling thermo. OFF (Fan)/Setup air volume operation continues.) <ul style="list-style-type: none"> α is corrected according to the outside temperature. <table border="1" style="margin-left: 20px;"> <thead> <tr> <th>Outside temp.</th> <th>Correction value (α)</th> </tr> </thead> <tbody> <tr> <td>No To</td> <td>0K</td> </tr> <tr> <td>$To \geq 24^\circ\text{C}$</td> <td>-1K</td> </tr> <tr> <td>$24^\circ\text{C} > To \geq 18^\circ\text{C}$</td> <td>0K</td> </tr> <tr> <td>$To < 18^\circ\text{C}$</td> <td>+1K</td> </tr> <tr> <td>To error</td> <td>0K</td> </tr> </tbody> </table> </td> </tr> </tbody> </table> <p style="margin-left: 20px;">Ta: Room temp. Ts: Setup temp. To: Outside temp.</p> <p style="margin-left: 20px;">K = deg</p>	Remote controller command	Control outline	STOP	Air conditioner stops.	FAN	Fan operation	COOL	Cooling operation	DRY	Dry operation	HEAT	Heating operation	AUTO	<ul style="list-style-type: none"> COOL/HEAT operation mode is automatically selected by Ta, Ts and To for operation. The operation is performed as shown in the following figure according to Ta value at the first time only. (In the range of $T_s + \alpha - 1 < T_a < T_s + \alpha + 1$, Cooling thermo. OFF (Fan)/Setup air volume operation continues.) <ul style="list-style-type: none"> α is corrected according to the outside temperature. <table border="1" style="margin-left: 20px;"> <thead> <tr> <th>Outside temp.</th> <th>Correction value (α)</th> </tr> </thead> <tbody> <tr> <td>No To</td> <td>0K</td> </tr> <tr> <td>$To \geq 24^\circ\text{C}$</td> <td>-1K</td> </tr> <tr> <td>$24^\circ\text{C} > To \geq 18^\circ\text{C}$</td> <td>0K</td> </tr> <tr> <td>$To < 18^\circ\text{C}$</td> <td>+1K</td> </tr> <tr> <td>To error</td> <td>0K</td> </tr> </tbody> </table>	Outside temp.	Correction value (α)	No To	0K	$To \geq 24^\circ\text{C}$	-1K	$24^\circ\text{C} > To \geq 18^\circ\text{C}$	0K	$To < 18^\circ\text{C}$	+1K	To error	0K	
Remote controller command	Control outline																												
STOP	Air conditioner stops.																												
FAN	Fan operation																												
COOL	Cooling operation																												
DRY	Dry operation																												
HEAT	Heating operation																												
AUTO	<ul style="list-style-type: none"> COOL/HEAT operation mode is automatically selected by Ta, Ts and To for operation. The operation is performed as shown in the following figure according to Ta value at the first time only. (In the range of $T_s + \alpha - 1 < T_a < T_s + \alpha + 1$, Cooling thermo. OFF (Fan)/Setup air volume operation continues.) <ul style="list-style-type: none"> α is corrected according to the outside temperature. <table border="1" style="margin-left: 20px;"> <thead> <tr> <th>Outside temp.</th> <th>Correction value (α)</th> </tr> </thead> <tbody> <tr> <td>No To</td> <td>0K</td> </tr> <tr> <td>$To \geq 24^\circ\text{C}$</td> <td>-1K</td> </tr> <tr> <td>$24^\circ\text{C} > To \geq 18^\circ\text{C}$</td> <td>0K</td> </tr> <tr> <td>$To < 18^\circ\text{C}$</td> <td>+1K</td> </tr> <tr> <td>To error</td> <td>0K</td> </tr> </tbody> </table>	Outside temp.	Correction value (α)	No To	0K	$To \geq 24^\circ\text{C}$	-1K	$24^\circ\text{C} > To \geq 18^\circ\text{C}$	0K	$To < 18^\circ\text{C}$	+1K	To error	0K																
Outside temp.	Correction value (α)																												
No To	0K																												
$To \geq 24^\circ\text{C}$	-1K																												
$24^\circ\text{C} > To \geq 18^\circ\text{C}$	0K																												
$To < 18^\circ\text{C}$	+1K																												
To error	0K																												
3	Room temp. control	<p>1) Adjustment range: Remote controller setup temperature °C</p> <table border="1" style="margin-left: 20px;"> <thead> <tr> <th></th> <th>COOL/DRY</th> <th>HEAT</th> <th>AUTO</th> </tr> </thead> <tbody> <tr> <td>Wired type *</td> <td colspan="3">18°C to 29°C</td> </tr> <tr> <td>Wireless type</td> <td colspan="3">17°C to 30°C</td> </tr> </tbody> </table> <p>* When use of remote sensor is set (with DN32), even when sensor value is within the above range in HEAT or AUTO mode, the thermo. sensor turns OFF when Ta sensor value exceeds 35°C.</p>		COOL/DRY	HEAT	AUTO	Wired type *	18°C to 29°C			Wireless type	17°C to 30°C																	
	COOL/DRY	HEAT	AUTO																										
Wired type *	18°C to 29°C																												
Wireless type	17°C to 30°C																												

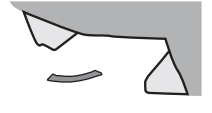
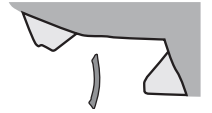

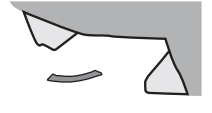
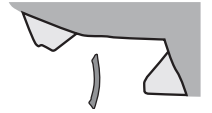

No.	Item	Outline of specifications	Remarks																
3	Room temp. control (Continued)	<p>2) Using the CODE No. 06, the setup temperature in heating operation can be corrected.</p> <table border="1" data-bbox="443 286 1102 398"> <tr> <td>SET DATA</td> <td>0</td> <td>2</td> <td>3</td> <td>4</td> <td>5</td> <td>6</td> </tr> <tr> <td>Setup temp. correction</td> <td>0°C</td> <td>1°C</td> <td>2°C</td> <td>3°C</td> <td>4°C</td> <td>5°C</td> </tr> </table> <p>Setting at shipment</p> <table border="1" data-bbox="443 459 762 504"> <tr> <td>SET DATA</td> <td>3</td> </tr> </table> <ul style="list-style-type: none"> When use of remote controller sensor is set (with DN32), no correction is performed. 	SET DATA	0	2	3	4	5	6	Setup temp. correction	0°C	1°C	2°C	3°C	4°C	5°C	SET DATA	3	Shift of suction temperature in heating operation
SET DATA	0	2	3	4	5	6													
Setup temp. correction	0°C	1°C	2°C	3°C	4°C	5°C													
SET DATA	3																		
4	Automatic capacity control (GA control)	<p>1) Based on the difference between Ta and Ts, the operation frequency is instructed to the outdoor unit.</p> <p>2) Cooling operation Every 90 seconds, the room temperature difference between temperature detected by Ta and Ts and the varied room temperature value are calculated to obtain the correction value of the frequency command and then the present frequency command is corrected.</p> <p style="margin-left: 20px;">Ta (n) – Ts (n) : Room temp. difference n : Counts of detection Ta (n-1) – Ts (n-1) : Varied room temp. value n – 1 : Counts of detection of 90 seconds before</p> <p>3) Heating operation Every 1 minute (60 sec.), the room temperature difference between temperature detected by Ta and Ts and the varied room temperature value are calculated to obtain the correction value of the frequency command and then the present frequency command is corrected.</p> <p style="margin-left: 20px;">Ts (n) – Ta (n) : Room temp. difference n : Counts of detection Ta (n) – Ta (n – 1) : Varied room temp. value n – 1 : Counts of detection of 1 minute before</p> <p>4) Dry operation The frequency correction control is same as those of the cooling operation. However the maximum frequency is limited to approximately “S6”.</p> <p>Note) When LOW is set up, the maximum frequency is limited to approximately “SB”.</p>																	
5	Automatic cooling/heating control	<p>1) The judgment of selecting COOL/HEAT is carried out as shown below. When +1.5°C exceeds against Tsh 10 minutes and after thermo.-OFF, heating operation (Thermo. OFF) exchanges to cooling operation. Description in the parentheses shows an example of cooling ON/OFF.</p> <div style="text-align: center;">  </div> <p>When –1.5°C lowers against Tsc 10 minutes and after thermo. OFF, cooling operation (Thermo. OFF) exchanges to heating operation.</p> <p>2) For the automatic capacity control after judgment of cooling/heating, see Item 4.</p> <p>3) For temperature correction of room temp. control in automatic heating, see Item 3.</p>	<p>Tsc: Setup temp. in cooling operation</p> <p>Tsh: Setup temp. in heating operation + temp. correction of room temp. control</p>																

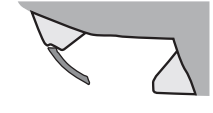
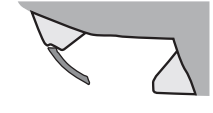
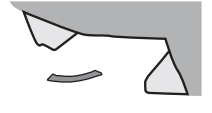
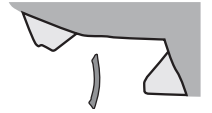
No.	Item	Outline of specifications	Remarks
6	Fan speed control	<p>1) Operation with (HH), (H), (L) or [AUTO] mode is carried out by the command from the remote controller.</p> <p>2) When the fan speed mode [AUTO] is selected, the fan speed varies by the difference between Ta and Ts.</p> <p><COOL></p> <p><HEAT></p> <p>Value in the parentheses indicates one when thermostat of the remote controller works. Value without parentheses indicates one when thermostat of the body works.</p> <ul style="list-style-type: none"> If the fan speed has been changed once, it is not changed for 3 minutes. However when the air volume is exchanged, the fan speed changes. When cooling operation has started, select a downward slope for the fan speed, that is, the high position. If the temperature is just on the difference boundary, the fan speed does not change. Mode in the parentheses indicates one in automatic cooling operation. <p><HEAT></p> <ul style="list-style-type: none"> If the fan speed has been changed once, it is not changed for 1 minute. However when the fan speed is exchanged, the fan speed changes. When heating operation has started, select an upward slope for the fan speed, that is, the high position. If the temperature is just on the difference boundary, the fan speed does not change. Mode in the parentheses indicates one in automatic heating operation. In $T_c \geq 60^\circ\text{C}$, the fan speed increases by 1 step. 	<p>HH > H+ > H > L+ > L > UL</p> <p>Wireless type allows HH, H+, H, L+, L and AUTO.</p> <p>Tc: Indoor heat exchanger sensor temperature</p>

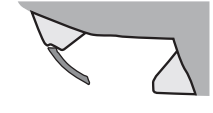





No.	Item	Outline of specifications	Remarks																																								
6	Fan speed control (Continued)	<p>Fan speed [rpm]</p> <table border="1" data-bbox="475 255 1141 663"> <thead> <tr> <th>COOL</th> <th>HEAT</th> <th>SM56</th> <th>SM80</th> </tr> </thead> <tbody> <tr> <td></td> <td>HH</td> <td>1080</td> <td>1260</td> </tr> <tr> <td>HH</td> <td></td> <td>1080</td> <td>1240</td> </tr> <tr> <td>H+</td> <td>H+</td> <td>1020</td> <td>1080</td> </tr> <tr> <td></td> <td>H</td> <td>1000</td> <td>1020</td> </tr> <tr> <td>H</td> <td></td> <td>980</td> <td>980</td> </tr> <tr> <td></td> <td>L+</td> <td>980</td> <td>980</td> </tr> <tr> <td>L+</td> <td>L</td> <td>940</td> <td>940</td> </tr> <tr> <td>L</td> <td></td> <td>900</td> <td>900</td> </tr> <tr> <td>UL</td> <td>UL</td> <td>500</td> <td>500</td> </tr> </tbody> </table> <p>3) When thermo sensor turns OFF during heating, the fan speed mode becomes UL (weak).</p> <p>4) When Ta is 25°C or above at the beginning of HEAT operation or when canceling defrost mode, H or HH mode continues for 1 minute from the time when Tc enters zone E. (Following figure.)</p> <p>5) The HH fan speed for auto cooling/heating is set to a speed higher than that for normal cooling/heating. However, it varies depending on the temperature difference of Tc during auto heating.</p>  <p>The graph shows Ta (°C) on the y-axis with values 42 and 47. The x-axis represents time. The temperature rises to 47°C, then stays constant for a period labeled 'HH'. It then falls to 42°C, where it stays constant for a period labeled 'HH+α'. After this, the temperature continues to fall.</p>	COOL	HEAT	SM56	SM80		HH	1080	1260	HH		1080	1240	H+	H+	1020	1080		H	1000	1020	H		980	980		L+	980	980	L+	L	940	940	L		900	900	UL	UL	500	500	<p>“PRE-HEAT ” indication</p>
COOL	HEAT	SM56	SM80																																								
	HH	1080	1260																																								
HH		1080	1240																																								
H+	H+	1020	1080																																								
	H	1000	1020																																								
H		980	980																																								
	L+	980	980																																								
L+	L	940	940																																								
L		900	900																																								
UL	UL	500	500																																								
7	Cool air discharge preventive control	<p>1) In heating operation, the indoor fan is controlled based on the detected temperature of Tc sensor or Tcj sensor. As shown below, the upper limit of the revolution frequency is restricted.</p> <p>However B zone is assumed as C zone for 6 minutes and after when the compressor activated.</p> <p>In defrost operation, the control value of Tc or Tcj is shifted by 6°C.</p>  <p>The graph shows Tc, Tcj (°C) on the y-axis with values 16, 20, 26, 28, 30, 32. The x-axis represents time. Horizontal lines represent temperature thresholds for zones: A zone (16°C), B zone (20°C), C zone (26°C), D zone (28°C), and E zone (30°C). Fan speed modes are shown as lines that decrease as temperature drops: HH (at 32°C), H (at 30°C), L (at 28°C), UL (at 26°C), and OFF (at 20°C). The modes transition to the next lower mode as the temperature crosses the corresponding zone threshold.</p>	<p>In D and E zones, the priority is given to air volume selection setup of remote controller.</p>																																								





No.	Item	Outline of specifications	Remarks								
8	Freeze preventive control (Low temperature release)	<p>1) The cooling operation (including Dry operation) is performed as follows based on the detected temperature of Tc sensor or Tcj sensor.</p> <p>When [J] zone is detected for 6 minutes (Following figure), the commanded frequency is decreased from the real operation frequency.</p> <p>After then the commanded frequency changes every 30 seconds while operation is performed in [J] zone.</p> <p>In [K] zone, time counting is interrupted and the operation is held.</p> <p>When [I] zone is detected, the timer is cleared and the operation returns to the normal operation.</p> <p>If the commanded frequency becomes S0 because the operation continues in [J] zone, the return temperature A is raised from 8°C to 12°C until [I] zone is detected and the indoor fan operates with [L] mode.</p>  <p>In heating operation, the freeze-preventive control works if 4-way valve is not exchanged and the following conditions are satisfied. (However the temperature for J zone dashing control is changed from 5°C to -5°C.)</p> <p><Conditions></p> <ul style="list-style-type: none"> • When ① or ② is established 5 minutes after activation. ① $T_{cn} \leq T_c(n-1) - 5$ ② $T_{cn} < T_c(n-1) - 1$ and $T_{cn} \leq T_a < 5^\circ\text{C}$ 	<p>Tcj: Indoor heat exchanger sensor temperature</p> <p>Tcn: Tc temperature when 5 minutes elapsed after activation</p> <p>Tc (n - 1): Tc temperature at start time</p>								
9	High-temp. release control	<p>1) The heating operation is performed as follows based on the detected temperature of Tc sensor or Tcj sensor.</p> <ul style="list-style-type: none"> • When [M] zone is detected, the commanded frequency is decreased from the real operation frequency. After then the commanded frequency changes every 30 seconds while operation is performed in [M] zone. • In [N] zone, the commanded frequency is held. • When [L] zone is detected, the commanded frequency is returned to the original value by approx. 6Hz every 60 seconds. <p>Setup at shipment</p> <table border="1" data-bbox="539 1724 992 1881"> <thead> <tr> <th colspan="2">Control temp. °C</th> </tr> <tr> <th>A</th> <th>B</th> </tr> </thead> <tbody> <tr> <td>56</td> <td>52</td> </tr> <tr> <td>54</td> <td>52</td> </tr> </tbody> </table>  <p>NOTE: When the operation has started or when Tc or Tcj < 30°C at start of the operation or after operation start, temperature is controlled between values in parentheses of A and B.</p>	Control temp. °C		A	B	56	52	54	52	
Control temp. °C											
A	B										
56	52										
54	52										

No.	Item	Outline of specifications	Remarks													
10	After-heat elimination	When heating operation stops, in some cases, the indoor fan operates with (L) for approx. 30 seconds.														
11	Louver control	<p>1) During the first operation after power on, louver position is controlled automatically according to operation mode (COOL/HEAT).</p> <table border="1" data-bbox="507 439 992 663"> <thead> <tr> <th data-bbox="507 439 751 483">Cooling</th> <th data-bbox="751 439 992 483">Heating</th> </tr> </thead> <tbody> <tr> <td data-bbox="507 483 751 618"></td> <td data-bbox="751 483 992 618"></td> </tr> <tr> <td data-bbox="507 618 751 663">48°</td> <td data-bbox="751 618 992 663">80°</td> </tr> </tbody> </table> <p>2) When louver position is controlled by remote controller, the unit's microcomputer memorizes the position for use in the next operation. * The memorized louver position is cleared when power is turned off, and returns to the state of 1) above.</p> <p>3) Louver position setting • Louver position can be set within the range below.</p> <table data-bbox="485 949 1011 1106"> <tr> <td data-bbox="485 949 751 994">COOL/DRY</td> <td data-bbox="751 949 1011 994">HEAT/FAN</td> </tr> <tr> <td data-bbox="485 994 751 1106"></td> <td data-bbox="751 994 1011 1106"></td> </tr> </table> <p>4) Swing setting • Louver moves within the range below.</p> <p>All operation modes</p>  <p>5) When air conditioner operation stops, louver closes automatically. It keeps its position in the event of an alarm.</p> <p>6) Louver tilts upward automatically during preparation for heating.</p>	Cooling	Heating			48°	80°	COOL/DRY	HEAT/FAN			<p>Louver angle: 0° (full close)</p> <table border="1" data-bbox="1177 439 1430 663"> <thead> <tr> <th data-bbox="1177 439 1430 483">Full close</th> </tr> </thead> <tbody> <tr> <td data-bbox="1177 483 1430 618"></td> </tr> <tr> <td data-bbox="1177 618 1430 663">0°</td> </tr> </tbody> </table> <p>Alarm: A code number (except F08 and L31) appears on the remote controller and the indoor unit stops.</p>	Full close		0°
Cooling	Heating															
																
48°	80°															
COOL/DRY	HEAT/FAN															
																
Full close																
																
0°																
12	HA control	<p>1) This control is connected to TV control or remote start/stop I/F, etc, and start/stop are available by HA signal input from the remote position.</p> <p>2) This control outputs start/stop status to HA output terminal.</p> <p>3) I/O specifications conform to JEMA regulations.</p>	In the group operation, use this control by connecting to either master or follower indoor unit.													

No.	Item	Outline of specifications	Remarks
13	Frequency fixed operation (Test run)	<p><In case of wireless remote controller></p> <ol style="list-style-type: none"> 1) Push [ON/OFF]  button. 2) Using [SELECT]  button, set [COOL] or [HEAT] to the operation mode to drive the air conditioner. 3) Set [HIGH ] to the fan speed. 4) To change the temperature setting, repeat it 6 times to COOL and HEAT operations each. <ul style="list-style-type: none"> COOL: 17°C ↔ 18°C <ul style="list-style-type: none"> 17°C → 18°C → 17°C → 18°C → 17°C → 18°C → 17°C → (test run) → ON/OFF HEAT: 30°C ↔ 29°C <ul style="list-style-type: none"> 30°C → 29°C → 30°C → 29°C → 30°C → 29°C → 30°C → (test run) → ON/OFF <ul style="list-style-type: none"> • Change an operation setting within 3 seconds. • The error detection is performed as usual. • The frequency-fixed operation is performed. 5) To finish a test run, push [ON/OFF]  button. 	
14	Filter sign display (Except wireless type) * It is provided on the separately sold type TCB-AX21E2 TCB-AX32E2	<ol style="list-style-type: none"> 1) The operation time of the indoor fan is calculated, the filter reset signal is sent to the remote controller when the specified time (150H) has passed, and it is displayed on LCD. 2) When the filter reset signal has been received from the remote controller, time of the calculation timer is cleared. <p>In this case, the measurement time is reset if the specified time has passed, and display on LCD disappears.</p>	FILTER [] goes on.
15	Central control mode selection	<ol style="list-style-type: none"> 1) Setting at the central controller side enables to select the contents which can be operated on the remote controller at indoor unit side. 2) RBC-AMT32E2 [Last push priority] : The operation contents can be selected from both remote controller and central controller of the indoor unit side, and the operation is performed with the contents selected at the last. [Center] : Start/Stop operation only can be handled on the remote controller at indoor unit side. [Operation Prohibited] : It cannot be operated on the remote controller at indoor unit side. (Stop status is held.) 	<p>(No display)</p> <p>[CENTER] goes on.</p> <p>[CENTER] goes on. In a case of wireless type, the display lamp does not change. However, contents which can be operated are same. The status set in [CENTER]/[Operation Prohibited] mode is notified with the receiving sound "Pi, Pi, Pi, Pi, Pi" (5 times).</p>



No.	Item	Outline of specifications	Remarks
16	Power-saving control	<ol style="list-style-type: none"> 1) Power-saving operation is available in the AUTO mode. 2) The set temperature is corrected using various sensor data within the range where comfort is maintained. 3) By using various sensor data including room temp. Ta, outside air temp. To, fan speed, and indoor unit heat exchange sensor temp. Tc, 20 minutes data is averaged to calculate a set temperature correction value. 4) The set temperature is corrected every 20 minutes with the following shift range. Cooling: +1.5 to -1.0K Heating: -1.5 to +1.0K 	
17	Max. frequency cut control	<ol style="list-style-type: none"> 1) This control is operated by selecting [AUTO] operation mode. 2) COOL operation mode: It is controlled according to the following figure if To < 28°C. <div style="text-align: center;"> </div> <ol style="list-style-type: none"> 3) HEAT operation mode: It is controlled according to the following figure if To > 15°C. <div style="text-align: center;"> </div>	
18	DC motor	<ol style="list-style-type: none"> 1) When the fan operation has started, positioning of the stator and the rotor are performed. (Moves slightly with tap sound) 2) The motor operates according to the command from the indoor controller. <p>Notes)</p> <ul style="list-style-type: none"> • When the fan rotates while the air conditioner stops due to entering of outside air, etc, the air conditioner may operate while the fan motor stops. • When a fan lock is found, the air conditioner stops, and an error is displayed. 	Check code [P12]

No.	Item	Outline of specifications	Remarks												
19	Self-clean operation (Dry operation)	<p>1) When cooling operation mode (AUTO COOL, COOL, DRY) stopped, the following three self-clean operations are performed.</p> <table border="1" data-bbox="491 293 1422 479"> <thead> <tr> <th>Compressor ON period</th> <th>Self-clean operation period</th> <th>FAN</th> <th>Louver</th> </tr> </thead> <tbody> <tr> <td>0 to 10 min.</td> <td>None</td> <td rowspan="3">450 rpm</td> <td rowspan="3">Position of 15° from all closes</td> </tr> <tr> <td>10 to 60 min.</td> <td>1 hour</td> </tr> <tr> <td>60 min. to</td> <td>2 hours</td> </tr> </tbody> </table> <p>2) During operation of self-clean,  lights on the wired remote controller screen. However the operation lamp (Green LED) goes off.</p> <p>3) To stop the self-clean operation, push twice the [ON/OFF] button on the remote controller continuously. (Stop the operation as compressor ON time in the table above: 10 minutes or below.)</p> <p>4) When the follower unit executes self-clean operation in the group connection, the segment of  is displayed on the wired remote controller screen via master unit.</p> <p>* If self-clean operation is not used, set invalidity (does not use) of the self-clean operation by changing [0001 (At shipment) of Item code (DN) [D3] to [0000].</p> <p>* To erase the  display during operation of self-clean, change Item code [D4] from [0000: Display (At shipment)] to [0001: Non-display].</p>	Compressor ON period	Self-clean operation period	FAN	Louver	0 to 10 min.	None	450 rpm	Position of 15° from all closes	10 to 60 min.	1 hour	60 min. to	2 hours	<p>On the remote controller before the wired remote controller (RBC-AMT31E), Self-clean operation display is not output. And it is not also on the wireless remote controller.</p> <p>It is recognized as [STOP] from the remote monitor side.</p>
Compressor ON period	Self-clean operation period	FAN	Louver												
0 to 10 min.	None	450 rpm	Position of 15° from all closes												
10 to 60 min.	1 hour														
60 min. to	2 hours														
20	Save operation (Wired remote controller specific operation)	<p>1) Turn on  button on the wired remote controller.</p> <p>2) During operation of save operation,  lights on the wired remote controller.</p> <p>3) During save operation, the current release control is performed with the restriction ratio set in EEPROM on the outdoor unit.</p> <p>4) The restriction ratio can be set by keeping  button pushed for 4 seconds or more on the remote controller.</p> <p>5) When validating the save operation, the next operation starts with save operation valid because contents are held even when operation stops, operation mode changes or power supply is reset.</p> <p>6) The restriction ratio can be set by changing the setup data of CODE No. (DN) [C2] in the range of 50 to 100% (every 1%, Setting at shipment: 75%).</p>	<p>Carry out setting operation during stop of the unit; otherwise the unit stops operation.</p> <p>For the setup operation, refer to “How to set up contents of save operation” of “10. SETUP AT LOCAL SITE AND OTHERS”.</p>												
21	Auto restart	<p>1) Object It restarts the operation automatically after resetting the unexpected stop of power supply such as power failure.</p> <p>2) Contents After returning from a power failure, the auto restart function reads the operation status from EEPROM and then restarts the operation automatically according to the operation contents.</p> <p>3) Setup of function exchange by wired remote controller CODE No. (DN): 28</p> <table border="1" data-bbox="491 1832 1129 1917"> <thead> <tr> <th>SET DATA</th> <th>0000</th> <th>0001</th> </tr> </thead> <tbody> <tr> <td>Auto restart</td> <td>None (At shipment)</td> <td>Provided</td> </tr> </tbody> </table>	SET DATA	0000	0001	Auto restart	None (At shipment)	Provided							
SET DATA	0000	0001													
Auto restart	None (At shipment)	Provided													

No.	Item	Outline of specifications	Remarks
22	8°C heating/ Frost protective operation (Wired remote controller specific operations)	<ol style="list-style-type: none"> 1) This function is intended for the cold latitudes and performs objective heating operation (8°C heating operation). 2) This function is valid only for combination with the outdoor units. 3) Using the indoor CODE No. [D1] (1 bit), Valid/Invalid of this function is set up at the customer's side. * The setup by CODE No. is Invalid [0]/Valid [1] and Invalid [0] has been set at the shipment. 4) This operation is the heating operation which sets 8°C as the setup temperature of the target. 5) This function starts operation by pushing temperature button  during heating operation; besides by pushing  button for 4 seconds or more after temperature reached the minimum set temperature. 6) To stop/release this operation, select and execute one from the following operations. <ol style="list-style-type: none"> ① Push  button: Heating operation (18°C setting) continues. ② Push [START/STOP] button: Air conditioner stops. (Heating 18°C operation at the next start) ③ Push  : Other operation mode is selected and the operation continues. 7) As the setup temperature is 8°C and the human heating is not targeted, the cold air discharge preventive control (Item 7) is made invalid to suppress the intermittent operation. 8) The settings of the air direction and air volume are changeable during this operation. 9) The indoor fan stops to protect the compressor for 2 minutes after start of heating operation (Thermo-ON) by this function. 	<p>In a group connection, if there is even one combination with other unit, "This function is not provided." is displayed.</p> <p>The setup temperature jumps from [18] to [8].</p>
23	Hi POWER operation (Wireless remote controller specific operations)	<p>When you push the Hi POWER button during cooling, heating or AUTO, the air conditioner will start the following operation.</p> <ul style="list-style-type: none"> • Cooling operation Performs the cooling operation at 1°C lower than the setting temperature. Only when the fan speed before the Hi POWER operation is not high, the fan speed will be increased. • Heating operation Performs the heating operation at 2°C higher than the setting temperature. Only when the fan speed before the Hi POWER operation is not high, the fan speed will be increased. 	<ul style="list-style-type: none"> • [Hi POWER] Display

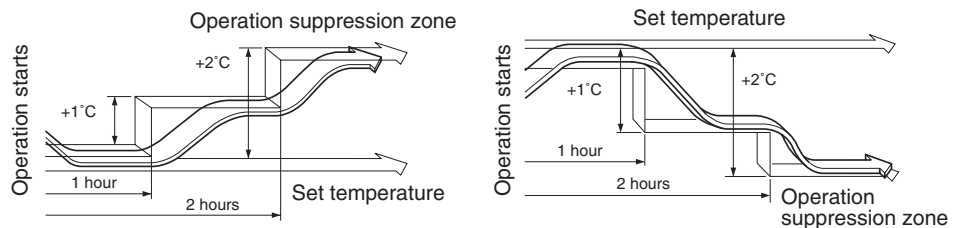
No.	Item	Outline of specifications	Remarks
24	COMFORT SLEEP operation (Wireless remote controller specific operations)	<p>When you push the COMFORT SLEEP button during cooling, heating or AUTO, the air conditioner will start the following operation.</p> <p>The fan speed display will indicate AUTO and low speed will be used.</p> <ul style="list-style-type: none"> Cooling operation In the operation suppression zone, where capacity is kept to the minimum, overcooling is prevented by raising the temperature setting by +1°C after 1 hour and by +2°C after 2 hours of operation. The room temperature is thus regulated between the operation suppression zone and the set temperature. When the OFF timer is simultaneously set, 1, 3, 5 and 9 hours appear by turns every pushing COMFORT SLEEP button and one of them can be selected for OFF timer. Heating operation In the operation suppression zone, where capacity is kept to the minimum, overheating is prevented by lowering the temperature setting by +1°C after 1 hour and by +2°C after 2 hours of operation. The room temperature is thus regulated between the set temperature and the operation suppression zone. When the OFF timer is simultaneously set, 1, 3, 5 and 9 hours appear by turns every pushing COMFORT SLEEP button and one of them can be selected for OFF timer. 	<ul style="list-style-type: none"> [] display



No.	Item	Outline of specifications	Remarks
25	PRESET operation (Wireless remote controller specific operations)	<p>Start the air conditioner in the operation mode which you want the remote controller to memorize.</p> <p>1) Push and hold the PRESET button for more than 3 seconds while the display flashes.</p> <p>The mark is indicated and the setting is memorized.</p> <ul style="list-style-type: none"> • If you do not push the PRESET button within 3 seconds or if you push another button, the memory setting is cancelled. • Operation modes which can be memorized with the PRESET button are MODE, Temperatures, FAN, TIMER and Hi POWER. <p>To operate the air conditioner with the setting memorized by the PRESET button.</p> <p>1) Push the PRESET button briefly.</p> <p>The setting memorized will be indicated and the air conditioner operates with regards to the setting.</p> <ul style="list-style-type: none"> • The lamp (green) on the display panel of the indoor unit goes on, and operation starts after approximately 3 minutes. • Initial setting: MODE : AUTO Temperature : 22°C 	<ul style="list-style-type: none"> • [] display
26	QUIET operation (Wireless remote controller specific operation)	<p>When you push the QUIET button during cooling, heating, fan only or AUTO, the air conditioner will start the following operation.</p> <ul style="list-style-type: none"> • The fan speed display will indicate AUTO and low speed will be used. 	<ul style="list-style-type: none"> • [] display
27	SLEEP operation (Wireless remote controller specific operation)	<p>When the OFF timer is set, 1, 3, 5 and 9 hours appear by turns every pushing SLEEP button and one of them can be selected for OFF timer.</p>	

7-3. Indoor Print Circuit Board (High Wall Type)

<MCC-1510>

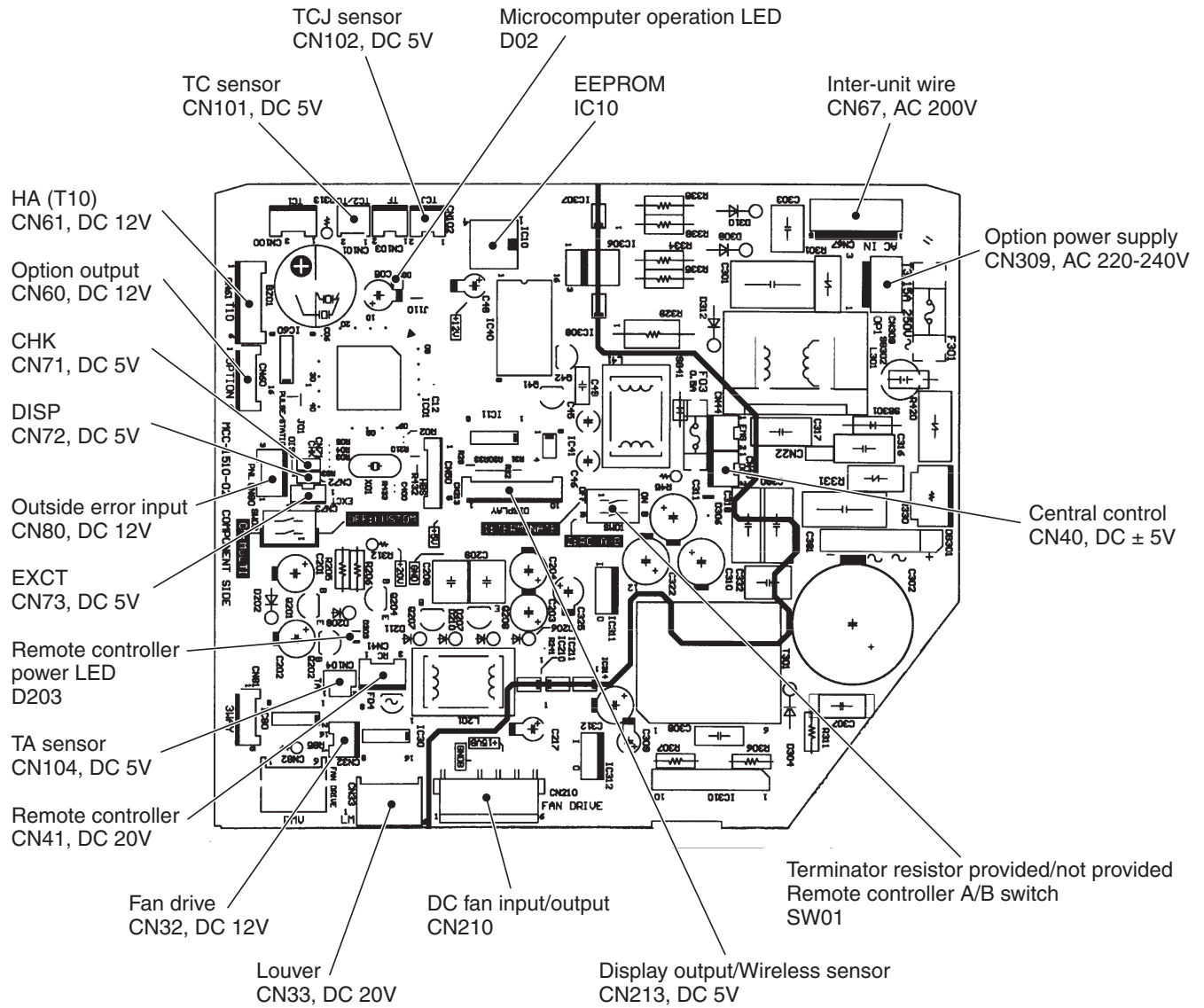

High Wall Type P.C. board optional switch/Connector specifications

Function	Connector No.	Pin No.	Specifications	Remarks
Terminator resistor provided/Not provided	SW01	Bit 1	OFF: No terminator resistor, ON: Terminator resistor provided	Setup at shipment OFF: No terminator resistor. Only 1 unit is ON during central control by custom only.
Remote controller A/B		Bit 2	OFF: Remote controller A ON: Remote controller B	Setup at shipment OFF: Remote controller A
Fan output	CN32	1	DC12V	Setup at shipment: Linked operation of ON with operation of indoor unit and OFF with stop
		2	Output	* The setup of single operation by FAN button on remote controller is executed from remote controller. (DN = 31)
HA	CN61	1	Start/Stop input	HA Start/Stop input (J01: Provided/Not provided = Pulse (At shipment from factory)/Static input switch)
		2	0V (COM)	
		3	Handy prohibition input	Operation stop of handy remote controller is permitted / prohibited by input.
		4	Operation output	ON during operation (Answer back of HA)
		5	DC12V (COM)	
		6	Alarm output	ON during output of alarm
Optional output	CN60	1	DC12V (COM)	
		2	Defrost output	ON during defrosting of outdoor unit
		3	Thermo-ON output	ON when Real thermo. ON (Comp. ON)
		4	Cooling output	ON when operation mode is cooling line (Cool, Dry, Cooling/Heating AUTO cooling)
		5	Heating output	ON when operation mode is heating line (Heat, Cooling/Heating AUTO heating)
		6	Fan output	ON when indoor fan is ON
Outside error input	CN80	1	DC12V (COM)	At shipment from factory, the error code "L30" generates and optional error input to stop operation forcedly (DN:2A = 1) is controlled (Display of protection for devices attached to outside) by setup of outside error input (DN:2A = 2) for 1 minute. * Optional error input control is set up on the remote controller.
		2	DC12V (COM)	
		3	Filter/Option/Outside error input	
CHK Operation check	CN71	1	Check mode input	This check is used for operation check of indoor unit. (The specified operation such as indoor fan "H", drain pump ON, etc. is executed without communication with outdoor unit or remote controller.)
		2	0V	
DISP Display mode	CN72	1	Display mode input	Display mode, communication is enabled by indoor unit and remote controller only. (When power supply is turned on.) Timer short (Usual)
		2	0V	
EXCT Demand	CN73	1	Demand input	Indoor unit forced thermo-OFF operation
		2	0V	

8. TROUBLESHOOTING

8-1. Summary of Troubleshooting

<Wired remote controller type>

1. Before troubleshooting

1) Required tools/instruments

- ⊕ and ⊖ screwdrivers, spanners, radio cutting pliers, nippers, push pins for reset switch
- Tester, thermometer, pressure gauge, etc.

2) Confirmation points before check

a) The following operations are normal.

1. Compressor does not operate.

- Is not 3-minutes delay (3 minutes after compressor OFF)?
- Is not the outdoor unit in standby status though the remote controller reached the setup temperature?
- Does not timer operate during fan operation?
- Is not an overflow error detected on the indoor unit?
- Is not outside high-temperature operation controlled in heating operation?

2. Indoor fan does not rotate.

- Does not cool air discharge preventive control work in heating operation?

3. Outdoor fan does not rotate or air volume changes.

- Does not high-temperature release operation control work in heating operation?
- Does not outside low-temperature operation control work in cooling operation?
- Is not defrost operation performed?

4. ON/OFF operation cannot be performed from remote controller.

- Is not the control operation performed from outside/remote side?
- Is not automatic address being set up?

(When the power is turned on at the first time or when indoor unit address setting is changed, the operation cannot be performed for maximum approx. 5 minutes after power-ON.)

- Is not being carried out a test run by operation of the outdoor controller?

b) Did you return the wiring to the initial positions?

c) Are connecting wires of indoor unit and remote controller correct?

2. Troubleshooting procedure

When a trouble occurred, check the parts along with the following procedure.



NOTE :

For cause of a trouble, power conditions or malfunction/erroneous diagnosis of microcomputer due to outer noise is considered except the items to be checked.

If there is any noise source, change the cables of the remote controller to shield cables.

<Wireless remote controller type>

1. Before troubleshooting

- 1) Required tools/instruments
 - ⊕ and ⊖ screwdrivers, spanners, radio cutting pliers, nippers, etc.
 - Tester, thermometer, pressure gauge, etc.
- 2) Confirmation points before check
 - a) The following operations are normal.
 1. Compressor does not operate.
 - Is not 3-minutes delay (3 minutes after compressor OFF)?
 - Is not the outdoor unit in standby status though the remote controller reached the setup temperature?
 - Does not timer operate during fan operation?
 - Is not an overflow error detected on the indoor unit?
 - Is not outside high-temperature operation controlled in heating operation?
 2. Indoor fan does not rotate.
 - Does not cool air discharge preventive control work in heating operation?
 3. Outdoor fan does not rotate or air volume changes.
 - Does not high-temperature release operation control work in heating operation?
 - Does not outside low-temperature operation control work in cooling operation?
 - Is not defrost operation performed?
 4. ON/OFF operation cannot be performed from remote controller.
 - Is not forced operation performed?
 - Is not the control operation performed from outside/remote side?
 - Is not automatic address being set up?
 - Is not being carried out a test run by operation of the outdoor controller?
 - b) Did you return the wiring to the initial positions?
 - c) Are connecting wires between indoor unit and receiving unit correct?

2. Troubleshooting procedure

(When the power is turned on at the first time or when indoor unit address setting is changed, the operation cannot be performed for maximum approx. 5 minutes after power-ON.)

When a trouble occurred, check the parts along with the following procedure.



1) Outline of judgment

The primary judgment to check where a trouble occurred in indoor unit or outdoor unit is performed with the following method.

Method to judge the erroneous position by flashing indication on the display part of indoor unit (sensors of the receiving unit)

The indoor unit monitors operating status of the air conditioner, and the blocked contents of self-diagnosis are displayed restricted to the following cases if a protective circuit works.

8-2. Troubleshooting (High Wall Type)



































8-2-1. Outline of judgment

The primary judgment to check whether a trouble occurred in the indoor unit or outdoor unit is carried out with the following method.



































Method to judge the erroneous position by flashing indication on the display part of the indoor unit

The indoor unit monitors the operating status of the air conditioner, and the blocked contents of self-diagnosis are displayed restricted to the following cases if a protective circuit works.

● : Go off, ○ : Go on,  : Flash (0.5 sec.)











Lamp indication	Check code	Cause of trouble occurrence	
Ready  Timer  Operation  ● ● ● No indication at all	—	Power supply OFF or miswiring between receiving unit and indoor unit	
Ready  Timer  Operation  ● ●  Flash	E01	Receiving error } Receiving unit } Sending error } Miswiring or wire connection error between receiving unit and indoor unit Communication stop }	
	E02		
	E03		
	Ready  Timer  Operation  ● ●  Flash	E08	Duplicated indoor unit No. } Duplicated master units of remote controller } Setup error
		E09	
		E10	Communication error between CPUs on indoor unit P.C. board
E18	Wire connection error between indoor units, Indoor power OFF (Communication stop between indoor master and follower or between main and sub indoor twin)		
Ready  Timer  Operation   ● ● Flash	E04	Miswiring between indoor unit and outdoor unit or connection error (Communication stop between indoor and outdoor units)	
Ready  Timer  Operation    ● Alternate flash	P01	Indoor AC fan error } Overflow was detected. } Protective device of indoor unit worked. Indoor DC fan error }	
	P10		
	P12		
Ready  Timer  Operation   ●  Alternate flash	P03	Outdoor unit discharge temp. error } Outdoor high pressure system error } Protective device of Case thermostat worked } outdoor unit worked. *1 Power supply error }	
	P04		
	Ready  Timer  Operation   ●  Alternate flash	P05	Power supply error } Heat sink overheat error } Outdoor unit error Gas leak detection error }
		P07	
		P15	
	P19	4-way valve system error (Indoor or outdoor unit judged.)	
	P20	Outdoor unit high pressure protection	
	Ready  Timer  Operation   ●  Alternate flash	P22	Outdoor unit: Outdoor unit error } Outdoor unit: Inverter Idc operation } Protective device of Outdoor unit: Position detection error } outdoor unit worked. *1
		P26	
		P29	
P31	Stopped because of error of other indoor unit in a group (Check codes of E03/L03/L07/L08)		

*1: These are representative examples and the check code differs according to the outdoor unit to be combined.

Lamp indication	Check code	Cause of trouble occurrence	
Ready  Timer  Operation  ●   Alternate flash	F01	Heat exchanger sensor (TCJ) error } Indoor unit sensor error Heat exchanger sensor (TC) error } Heat exchanger sensor (TA) error }	
	F02		
	F10		
Ready  Timer  Operation  ○   Alternate flash	F04	Discharge temp. sensor (TD) error } Sensor error of outdoor unit *1 Temp. sensor (TL, TS, TE) error } Temp. sensor (TD) error } Temp. sensor (TO) error } Temp. sensor (TS) error } Heat sink sensor (TH) error } Temp. sensor miswiring (TE, TS) }	
	F06		
	F07		
	F08		
	F12		
	F13		
	F15		
Ready  Timer  Operation  ●   Simultaneous flash	F29	Indoor EEPROM error	
Ready  Timer  Operation  ○   Simultaneous flash	F31	Outdoor EEPROM error	
Ready  Timer  Operation  ●  ● Flash	H01	Compressor break down } Outdoor compressor system error *1	
	H02		Compressor lock
	H03	Current detection circuit error	Power supply, outdoor P.C. board error
	H04	Case thermostat worked.	
Ready  Timer  Operation   ●  Simultaneous flash	L03	Duplicated master indoor units } There is indoor unit of group } connection in individual indoor unit. } → AUTO address Unsetting of group address } * If group construction and address Missed setting } are not normal when power supply (Unset indoor capacity) } turned on, automatically goes to address setup mode.	
	L07		
	L08		
	L09		
Ready  Timer  Operation   ○  Simultaneous flash	L10	Unset model type (Service board)	
	L20	Duplicated indoor central addresses	
	L29	Temp. sensor (TH) error EEPROM error Communication between outdoor MCU Heat sink overheat error Gas leak detection error 4-way valve error	
	L30	Outside interlock error	

*1: These are representative examples and the check code differs according to the outdoor unit to be combined.

8-2-2. Others (Other than Check Code)

Lamp indication	Check code	Cause of trouble occurrence
Ready Timer Operation       Simultaneous flash	—	During test run
Ready Timer Operation      ○ Alternate flash	—	Disagreement of cool/heat (Automatic cool/heat setting to automatic cool/heat prohibited model, or setting of heating to cooling-only model)

8-2-3. Check Code List (Indoor)

○ : Go on, ◎ : Flash, ● : Go off ALT (Alternate); Alternate flashing when there are two flashing LED SIM (Simultaneous); Simultaneous flashing when there are two flashing LED

(Indoor unit detected)

Check code indication	Sensor lamp indication		Representative defective position	Explanation of error contents	Air conditioner operation	
	Block indication	Flash			Automatic reset	Operation continuation
Wired remote controller	Ready	Timer Operation				
	●	◎	Regular communication error between indoor and remote controller	No communication from remote controller and network adapter (Also no communication from central control system)	○	×
	◎	●	Indoor/Outdoor serial error	There is error on serial communication between indoor and outdoor units	○	×
E08	●	◎	Duplicated indoor addresses	Same address as yours was detected.	○	×
E18	●	◎	Regular communication error between indoor master and follower units	Regular communication between indoor master and follower units is impossible. Communication between twin master (main) and follower (sub) units is impossible.	○	×
F01	●	◎	Indoor unit, Heat exchanger (TCJ) error	Open/short was detected on heat exchanger (TCJ).	○	×
F02	●	◎	Indoor unit, Heat exchanger (TC) error	Open/short was detected on heat exchanger (TC).	○	×
F10	●	◎	Indoor unit, Room temp. sensor (TA) error	Open/short was detected on room temp. sensor (TA).	○	×
F29	●	◎	Indoor unit, other indoor PC board error	EEPROM error (Other error may be detected. If no error, automatic address is repeated.)	×	×
L03	◎	●	Duplicated setting of indoor group master unit	There are multiple master units in a group.	×	×
L07	◎	●	There is group cable in individual indoor unit.	When even one group connection indoor unit exists in individual indoor unit.	×	×
L08	◎	●	Unset indoor group address	Indoor group address is unset.	×	×
L09	◎	●	Unset indoor capacity	Capacity of indoor unit is unset.	×	×
L20	◎	○	Duplicated central control system address	Duplicated setting of central control system address	○	×
L30	◎	○	Outside error input to indoor unit (Interlock)	Abnormal stop by outside error (CN80) input	×	×
P12	◎	◎	Indoor unit, DC fan error	Indoor DC fan error (Over-current/Lock, etc.) was detected.	×	×
P19	◎	●	4-way valve system error	In heating operation, an error was detected by temp. down of indoor heat exchanger sensor.	○	×
P31	◎	◎	Other indoor unit error	Follower unit in group cannot operate by warning from [E03/L03/L07/L08] of master unit.	○	×

◇ When this warning was detected before group construction/address check finish at power supply was turned on, the mode shifts automatically to AUTO address setup mode.

(Remote controller detected)

Check code indication	Sensor lamp indication		Representative defective position	Explanation of error contents	Air conditioner operation	
	Block indication	Flash			Automatic reset	Operation continuation
Wired remote controller	Ready	Timer Operation				
	●	◎	No master remote controller. Remote controller communication (Receive) error	Signal cannot be received from indoor unit. Master remote controller was not set. (including 2 remote controllers)	—	—
	●	◎	Remote controller communication (Send) error	Signal cannot be sent to indoor unit.	—	—
E09	●	◎	Duplicated master remote controller	In 2-remote controller control, both were set as master. (Indoor master unit stops warning and follower unit continues operation.)	×	△

(Central control devices detected)

Check code indication	Sensor lamp indication		Representative defective position	Explanation of error contents	Air conditioner operation	
	Block indication	Flash			Automatic reset	Operation continuation
TCC-LINK central	Ready	Timer Operation				
	Is not displayed. (Common use of remote controller, etc.)		Central control system communication (send) error	Signal sending operation of central control system is impossible. There are multiple same central devices. (AI-NET)	—	—
			Central control system communication (receive) error	Signal receiving operation of central control system is impossible.	—	—
C12	—	—	General-purpose device control interface batched warning	An error on device connected to general-purpose device control interface of exclusive to TCC-LINK/AI-NET	—	—
P30	By warning unit (Above-mentioned)		Group follower unit is defective.	Group follower unit is defective. (For remote controller, above-mentioned [***]) details are displayed with unit No.	—	—

NOTE: Even for the same contents of error such as communication error, the display of check code may differ according to detection device. When remote controller or central controller detects an error, it is not necessarily related to operation of the air conditioner. In this list, the check codes that outdoor unit detects are not described.

Error mode detected by indoor unit

Operation of diagnostic function				Judgment and measures
Check code	Cause of operation	Status of air conditioner	Condition	
E03	No communication from remote controller (including wireless) and communication adapter	Stop (Automatic reset)	Displayed when error is detected	1. Check cables of remote controller and communication adapters. • Remote controller LCD display OFF (Disconnection) • Central remote controller [97] check code
E04	The serial signal is not output from outdoor unit to indoor unit. • Miswiring of inter-unit wire • Defective serial sending circuit on outdoor P.C. board • Defective serial receiving circuit on indoor P.C. board	Stop (Automatic reset)	Displayed when error is detected	1. Outdoor unit does not completely operate. • Inter-unit wire check, correction of miswiring • Check outdoor P.C. board. Correct wiring of P.C. board. 2. When outdoor unit normally operates Check P.C. board (Indoor receiving / Outdoor sending).
E08	Duplicated indoor unit address	Stop	Displayed when error is detected	1. Check whether remote controller connection (Group/Individual) was changed or not after power supply turned on (Finish of group construction/Address check). * If group construction and address are not normal when the power has been turned on, the mode automatically shifts to address setup mode. (Resetting of address)
E18	Regular communication error between indoor aster and follower units and between main and sub units	Stop (Automatic reset)	Displayed when error is detected	1. Check remote controller wiring. 2. Check indoor power supply wiring. 3. Check indoor P.C. board.
F01	Coming-off, disconnection or short of indoor heat exchanger temp. sensor (TCJ)	Stop (Automatic reset)	Displayed when error is detected	1. Check indoor heat exchanger temp. sensor (TCJ). 2. Check indoor P.C. board.
F02	Coming-off, disconnection or short of indoor heat exchanger temp. sensor (TC)	Stop (Automatic reset)	Displayed when error is detected	1. Check indoor heat exchanger temp. sensor (TC). 2. Check indoor P.C. board.
F10	Coming-off, disconnection or short of indoor heat exchanger temp. sensor (TA)	Stop (Automatic reset)	Displayed when error is detected	1. Check indoor heat exchanger temp. sensor (TA). 2. Check indoor P.C. board.
F29	Indoor EEPROM error • EEPROM access error	Stop (Automatic reset)	Displayed when error is detected	1. Check indoor EEPROM. (including socket insertion) 2. Check indoor P.C. board.
L03	Duplicated indoor master unit	Stop	Displayed when error is detected	1. Check whether remote controller connection (Group/Individual) was changed or not after power supply turned on (Finish of group construction/Address check). * If group construction and address are not normal when the power has been turned on, the mode automatically shifts to address setup mode. (Resetting of address)
L07	There is group wire in individual indoor unit.			
L08	Unset indoor group address			
L09	Unset indoor capacity	Stop	Displayed when error is detected	1. Set indoor capacity (DN=11)
L30	Abnormal input of outside interlock	Stop	Displayed when error is detected	1. Check outside devices. 2. Check indoor P.C. board.
P12	Indoor DC fan error	Stop	Displayed when error is detected	1. Position detection error 2. Over-current protective circuit of indoor fan driving unit operated. 3. Indoor fan locked. 4. Check indoor P.C. board.
P19	4-way valve system error • After heating operation has started, indoor heat exchangers temp. is down.	Stop (Automatic reset)	Displayed when error is detected	1. Check 4-way valve. 2. Check 2-way valve and check valve. 3. Check indoor heat exchanger (TC/TCJ). 4. Check indoor P.C. board.
P31	Own unit stops while warning is output to other indoor units.	Stop (Follower unit) (Automatic reset)	Displayed when error is detected	1. Judge follower unit while master unit is [E03], [L03], [L07] or [L08]. 2. Check indoor P.C. board.

Error mode detected by remote controller or central controller (TCC-LINK)

Operation of diagnostic function				Judgment and measures
Check code	Cause of operation	Status of air conditioner	Condition	
Not displayed at all (Operation on remote controller is impossible.)	No communication with master indoor unit <ul style="list-style-type: none"> Remote controller wiring is not correct. Power of indoor unit is not turned on. Automatic address cannot be completed. 	Stop	—	Power supply error of remote controller, Indoor EEPROM error <ol style="list-style-type: none"> Check remote controller inter-unit wiring. Check remote controller. Check indoor power wiring. Check indoor P.C. board. Check indoor EEPROM. (including socket insertion) → Automatic address repeating phenomenon generates.
E01 *2	No communication with master indoor unit <ul style="list-style-type: none"> Disconnection of inter-unit wire between remote controller and master indoor unit (Detected by remote controller side) 	Stop (Automatic reset) * If center exists, operation continues.	Displayed when error is detected	Receiving error from remote controller <ol style="list-style-type: none"> Check remote controller inter-unit wiring. Check remote controller. Check indoor power wiring. Check indoor P.C. board.
E02	Signal send error to indoor unit (Detected by remote controller side)	Stop (Automatic reset) * If center exists, operation continues.	Displayed when error is detected	Sending error of remote controller <ol style="list-style-type: none"> Check sending circuit inside of remote controller. → Replace remote controller.
E09	There are multiple main remote controllers. (Detected by remote controller side)	Stop (Sub unit continues operation.)	Displayed when error is detected	<ol style="list-style-type: none"> In 2-remote controllers (including wireless), there are multiple main units. Check that there are 1 main remote controller and other sub remote controllers.
L20 ----- Central controller L20	Duplicated indoor central addresses on communication of central control system (Detected by indoor/central controller side)	Stop (Automatic reset)	Displayed when error is detected	<ol style="list-style-type: none"> Check setting of central control system network address. (Network adapter SW01) Check network adapter P.C. board.
----- *3 ----- Central controller (Send) C05 (Receive) C06	Communication circuit error of central control system (Detected by central controller side)	Continues (By remote controller)	Displayed when error is detected	<ol style="list-style-type: none"> Check communication wire / miswiring Check communication (U3, U4 terminals) Check network adapter P.C. board. Check central controller (such as central control remote controller, etc.) Check terminal resistance. (TCC-LINK)
----- Central controller P30	Indoor Gr sub unit error (Detected by central controller side)	Continuation/Stop (According to each case)	Displayed when error is detected	Check the check code of the corresponding unit from remote controller.

*2 The check code cannot be displayed by the wired remote controller.
(Usual operation of air conditioner becomes unavailable.)

For the wireless models, an error is notified with indication lamp.

*3 This trouble is related to communication of remote controller (A, B), central system (TCC-LINK U3, U4), and [E01], [E02], [E03], [E09] or [E18] is displayed or no check display on the remote controller according to the contents.

Error mode detected by outdoor unit

Operation of diagnostic function				Judgment and measures
Check code	Cause of operation	Status of air conditioner	Condition	
Indoor unit				
High Wall				
F04	Disconnection, short of discharge temp. sensor (TD)	Stop	Displayed when error is detected	1. Check discharge temp. sensor (TD). 2. Check outdoor P.C. board.
F06	Disconnection, short of outdoor temp. sensor (TE)	Stop	Displayed when error is detected	1. Check temp. sensor (TE). 2. Check outdoor P.C. board.
F07	Disconnection, short of outdoor temp. sensor (TL)	Stop	Displayed when error is detected	1. Check temp. sensor (TL). 2. Check outdoor P.C. board.
F08	Disconnection, short of outside temp. sensor (TO)	Continue	Displayed when error is detected	1. Check outside temp. sensor (TO). 2. Check outdoor P.C. board.
F12	Disconnection, short of suction temp. sensor (TS)	Stop	Displayed when error is detected	1. Check suction temp. sensor (TS). 2. Check outdoor P.C. board.
F13	Disconnection, short of heat sink temp. sensor (TH)	Stop	Displayed when error is detected	1. Check outdoor P.C. board.
F15	Miss-mounting of outdoor temp. sensor (TE, TS)	Stop	Displayed when error is detected	1. Check temp. sensor (TE, TS). 2. Check outdoor P.C. board.
F31	Outdoor P.C. EEPROM error	Stop	Displayed when error is detected	1. Check outdoor P.C. board.
H01	Compressor break down * Although operation has started, operation frequency decreases and operation stops.	Stop	Displayed when error is detected	1. Check power supply voltage. (AC208V/230V ±10V) 2. Overload operation of refrigerating cycle
H02	Compressor lock * Over-current detection after compressor start-up	Stop	Displayed when error is detected	1. Trouble of compressor (Lock, etc.): Replace compressor. 2. Wiring error of compressor (Open phase)
H03	Current detection circuit error	Stop	Displayed when error is detected	1. Check outdoor P.C. board. (AC current detection circuit)
H04	Case thermostat operation * Abnormal overheat of compressor	Stop	Displayed when error is detected	1. Check case thermostat and connector. 2. Check gas leak, recharge 3. Check full open of service valve. 4. Check PMV (Pulse Motor Valve). 5. Check broken pipe.
L10	Unset jumper of service P.C. board	Stop	Displayed when error is detected	1. Outdoor service P.C. board Check model type setting jumper wire.
L29	Communication error between outdoor P.C. board MCU	Stop	Displayed when error is detected	1. Check outdoor P.C. board.

Operation of diagnostic function				Judgment and measures
Check code	Cause of operation	Status of air conditioner	Condition	
Indoor unit				
High Wall				
P03	Discharge temp. error * Discharge temp. (TD) over specified value was detected.	Stop	Displayed when error is detected	<ol style="list-style-type: none"> 1. Check refrigerating cycle (Gas leak). 2. Trouble of electronic expansion valve. 3. Check discharge temp. sensor (TD).
P04	High pressure system error	Stop	Displayed when error is detected	<ol style="list-style-type: none"> 1. Freezing cycle overload operation. 2. Check outdoor heat exchange sensor (TE). 3. Check outdoor P.C. board. 4. Check high-pressure switch and circuit.
P05	Power supply voltage error	Stop	Displayed when error is detected	<ol style="list-style-type: none"> 1. Check power supply voltage. (AC208V/230V ±10V)
P07	Heat sink overheat error * Heat sink temp. sensor detected over specified temperature.	Stop	Displayed when error is detected	<ol style="list-style-type: none"> 1. Check screw tightening between PC. Board and heat sink and check radiator grease. 2. Check heat sink blast path.
P15	Detection of gas leak * Discharge temp. sensor (TD), Suction temp. sensor (TS) detected temperature over specified temp.	Stop	Displayed when error is detected	<ol style="list-style-type: none"> 1. Check gas leak, recharge. 2. Check full open of service valve. 3. Check PMV (Pulse Motor Valve). 4. Check broken pipe. 5. Check discharge temp. sensor (TD), suction temp. sensor (TS).
P19	4-way valve inverse error * After heating operation has started, indoor heat exchanger temp. lowers under the specified temp. * After heating operation has started, outdoor heat exchanger / suction temp. rises over the specified temp.	Stop	Displayed when error is detected	<ol style="list-style-type: none"> 1. Check operation of 4-way valve. 2. Check outdoor heat exchanger (TE), suction temp. sensor (TS). 3. Check indoor heat exchanger sensor (TC). 4. Check 4-way valve coil. 5. Check PMV (Pulse Motor Valve).
P20	High pressure protective operation • During cooling operation, outdoor temp. sensor (TL) detected temperature over specified temp. • During heating operation, indoor temp. sensor (TC, TCJ) detected temperature over specified temp.	Stop	Displayed when error is detected	<ol style="list-style-type: none"> 1. Check outdoor heat exchanger sensor (TL). 2. Check indoor heat exchanger sensor (TC, TCJ). 3. Check full open of service valve. 4. Check indoor/outdoor fan. 5. Check PMV (Pulse Motor Valve). 6. Check clogging and short circuit of indoor/outdoor heat exchanger. 7. Overcharge of refrigerant. Recharge
P22	Outdoor fan system error	Stop	Displayed when error is detected	<ol style="list-style-type: none"> 1. Check lock of fan motor. 2. Check power supply voltage. (AC208V/230V ±10V) 3. Check outdoor P.C. board.
P26	Short-circuit error of compressor driving element	Stop	Displayed when error is detected	<ol style="list-style-type: none"> 1. When performing operation while taking-off compressor wire, P26 error occurs. Check control P.C. board. 2. When performing operation while taking-off compressor wire, an error does not occur. (Compressor rare short)
P29	Position detection circuit error	Stop	Displayed when error is detected	<ol style="list-style-type: none"> 1. Check control P.C. board.

8-2-4. Diagnostic Procedure for Each Check Code (Indoor Unit)

Check code

[E01 error]

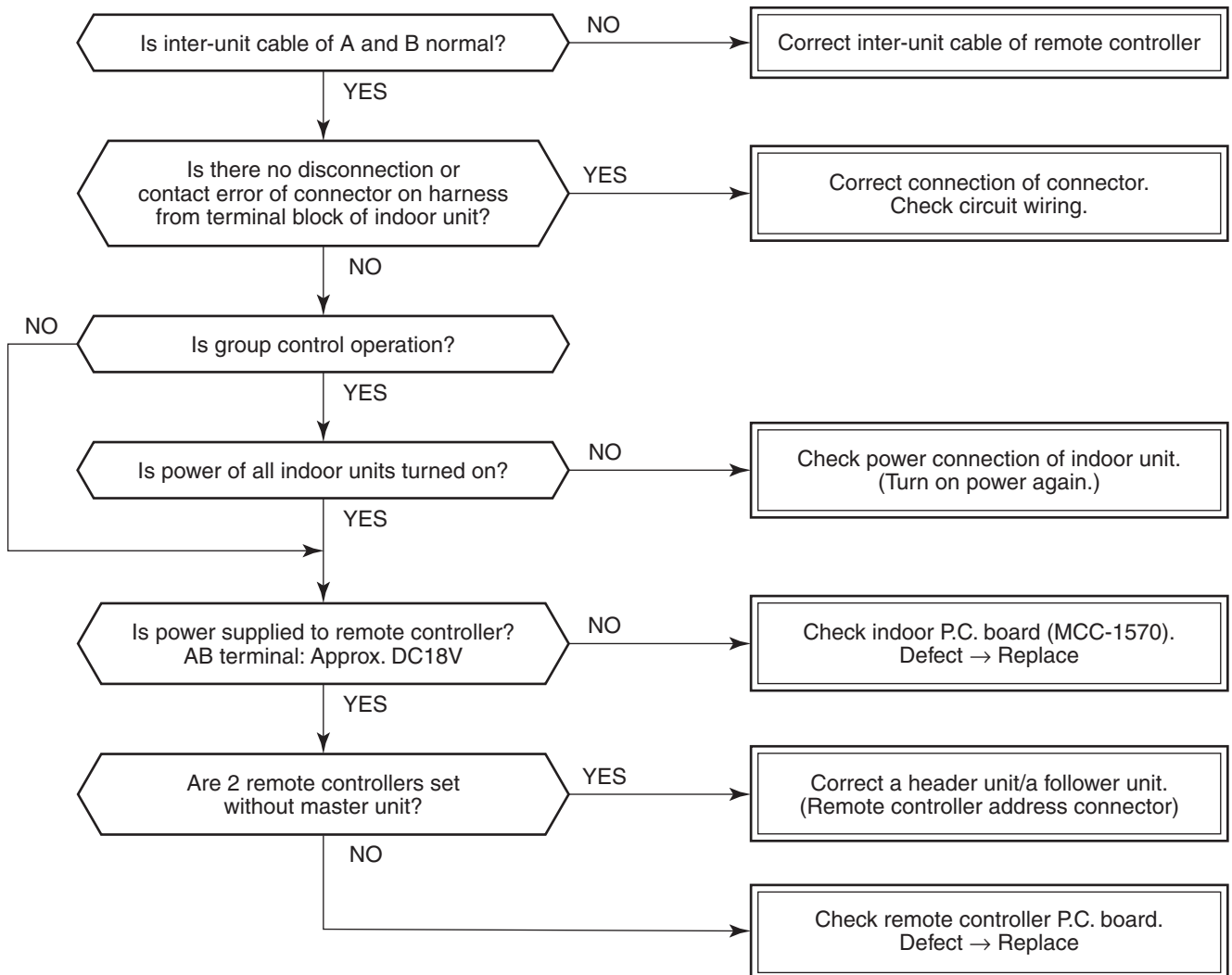

[E09 error]

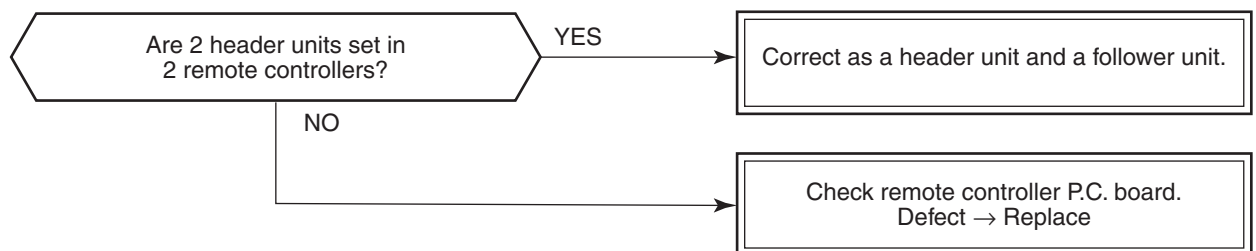

[E02 error]

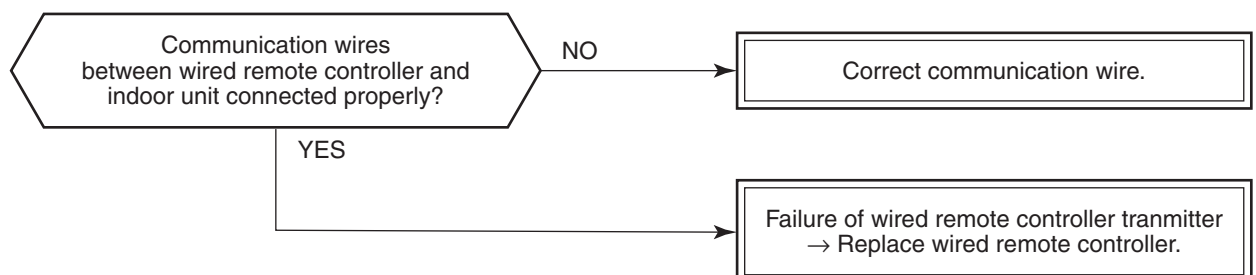

[E04 error]

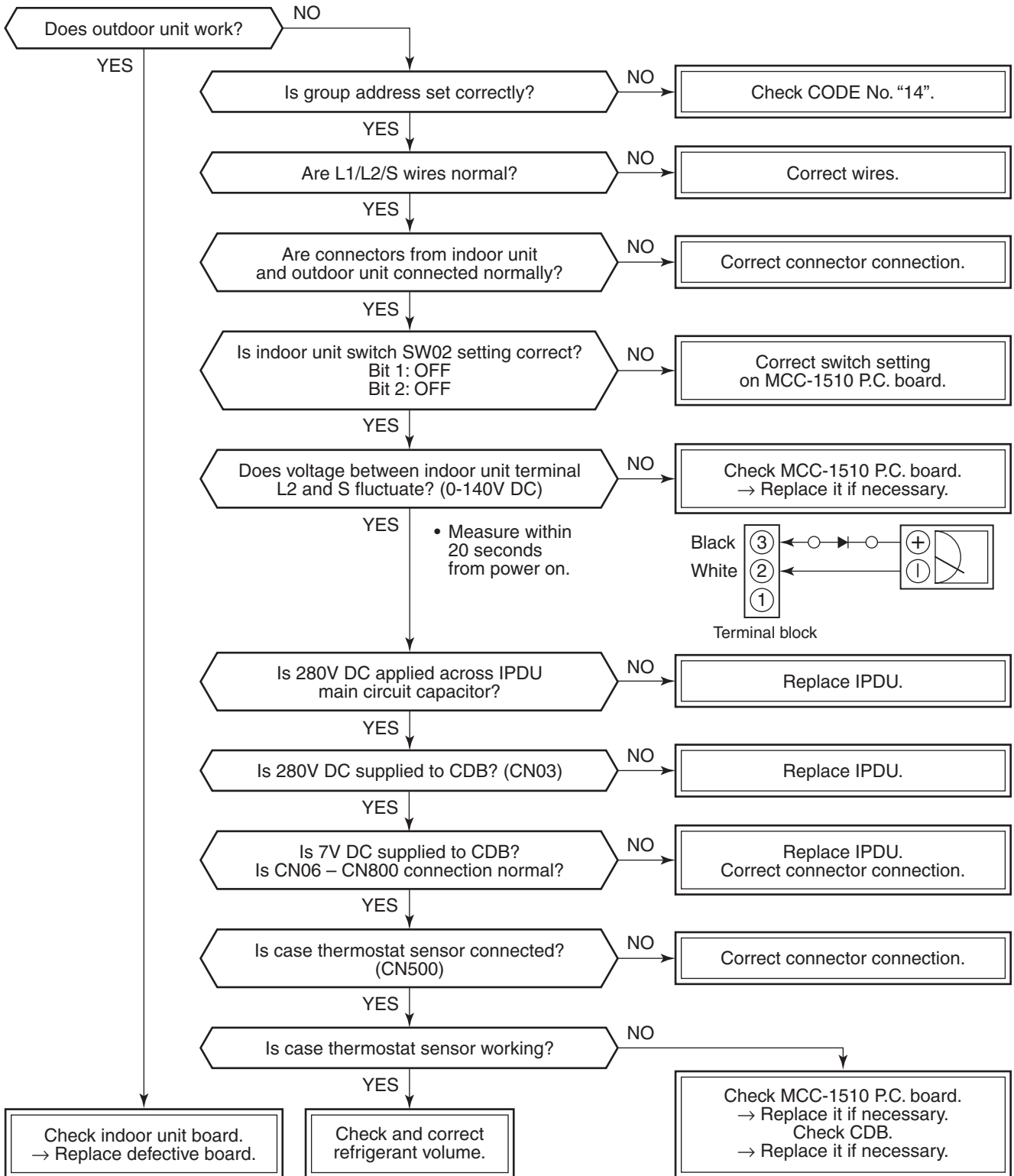

[E10 error]

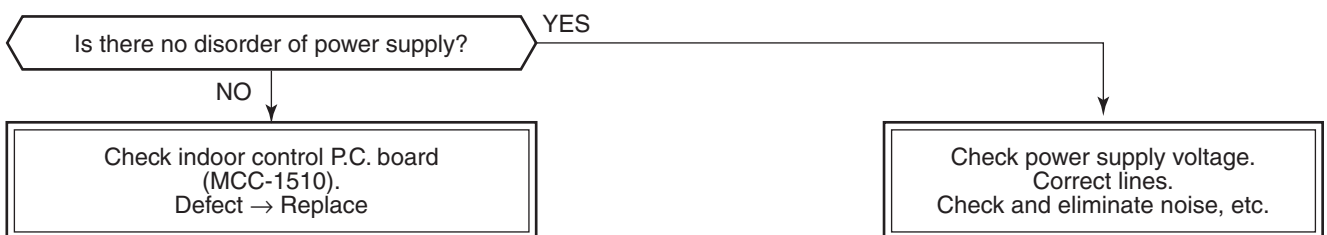

[E18 error]

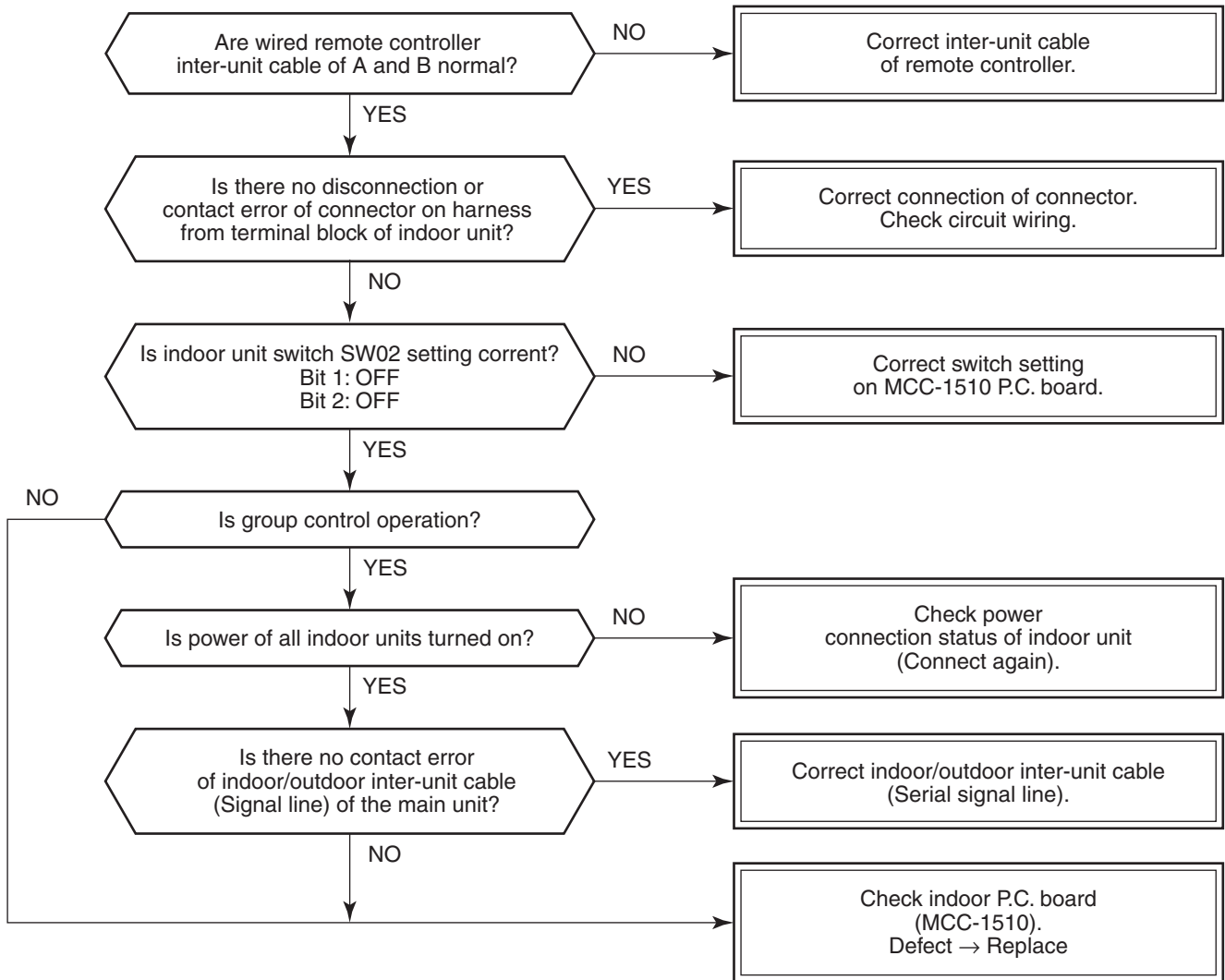

[E08, L03, L07, L08 error]

E08: Duplicated indoor unit No.

L03: There are 2 or more master units in a group control.

L07: There is 1 or more group address [Individual] in a group control.

L08: The indoor group address is unset. **(11. ADDRESS SETUP)**

If the above error is detected when power supply turned on, the mode enters automatically in the automatic address set mode. (Check code is not output.)

However, if the above error is detected during the automatic address set mode, a check code may be output.

[L09 error]

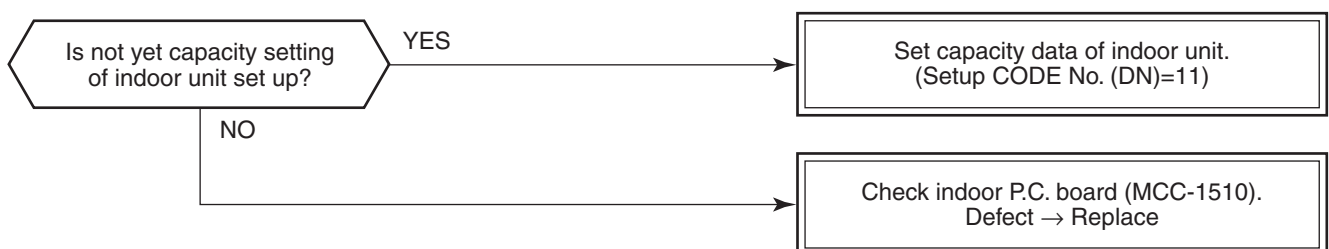

[E09 error]

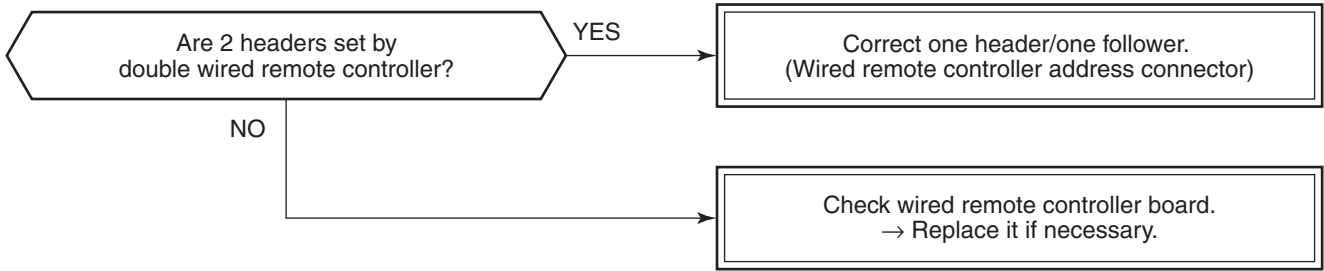

[E18 error]

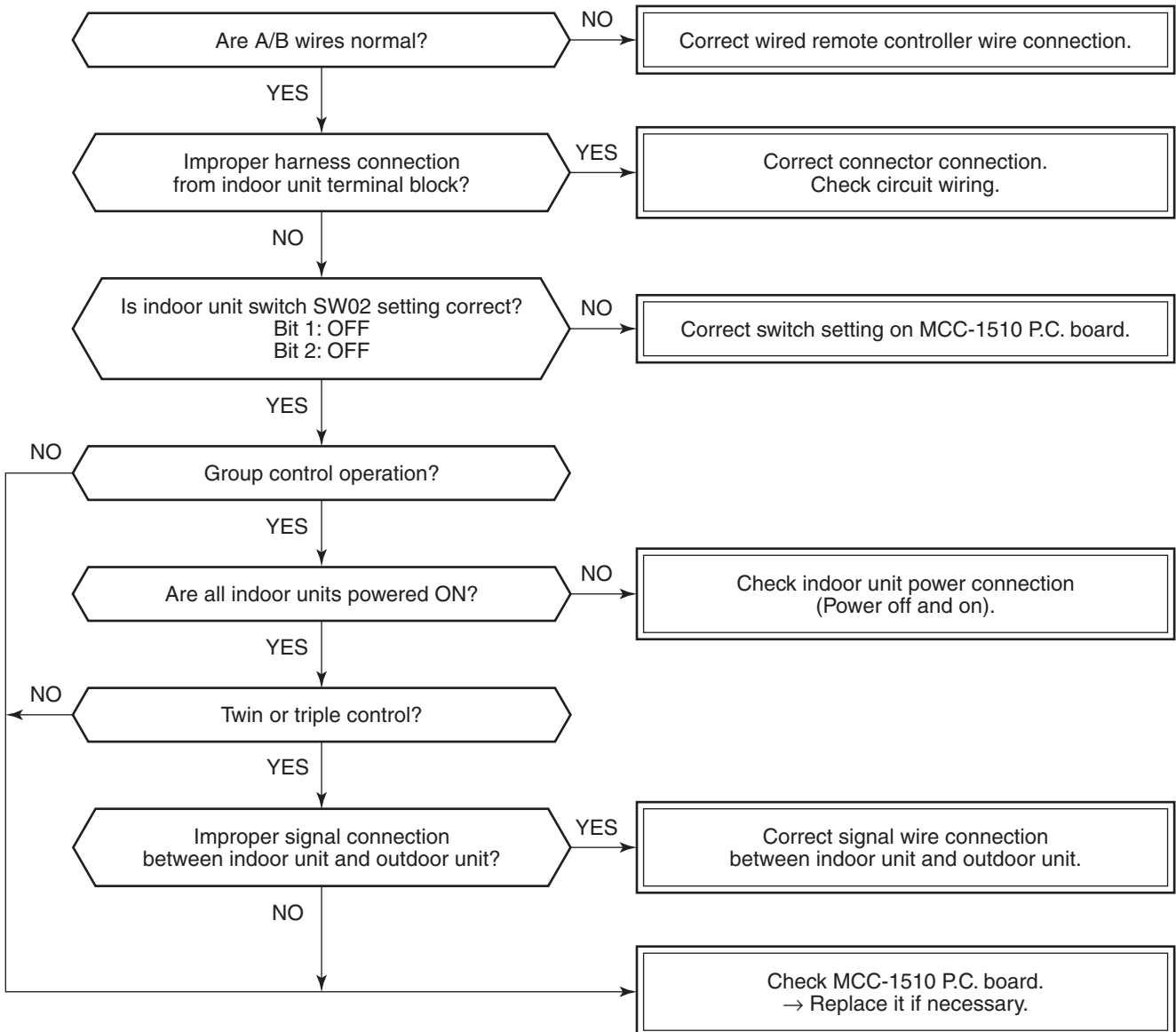

[L30 error]

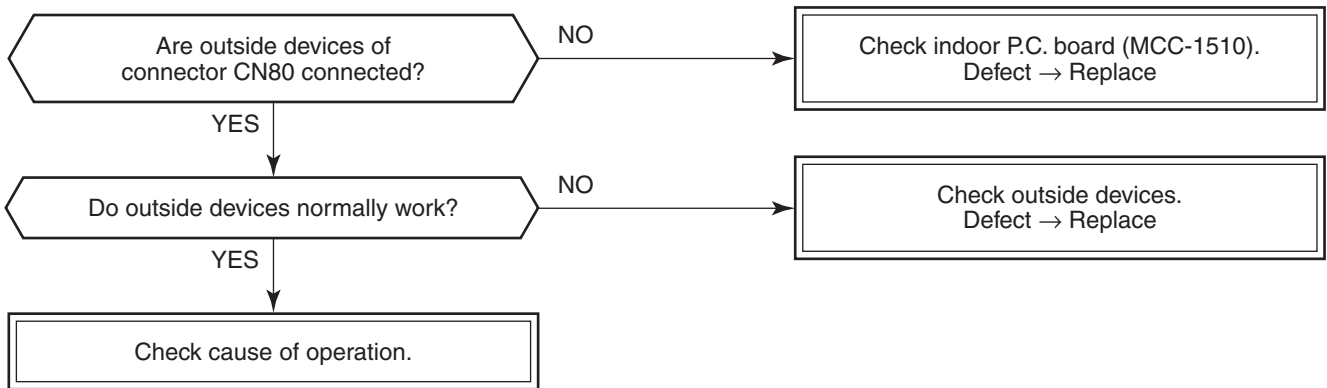

[F10 error]

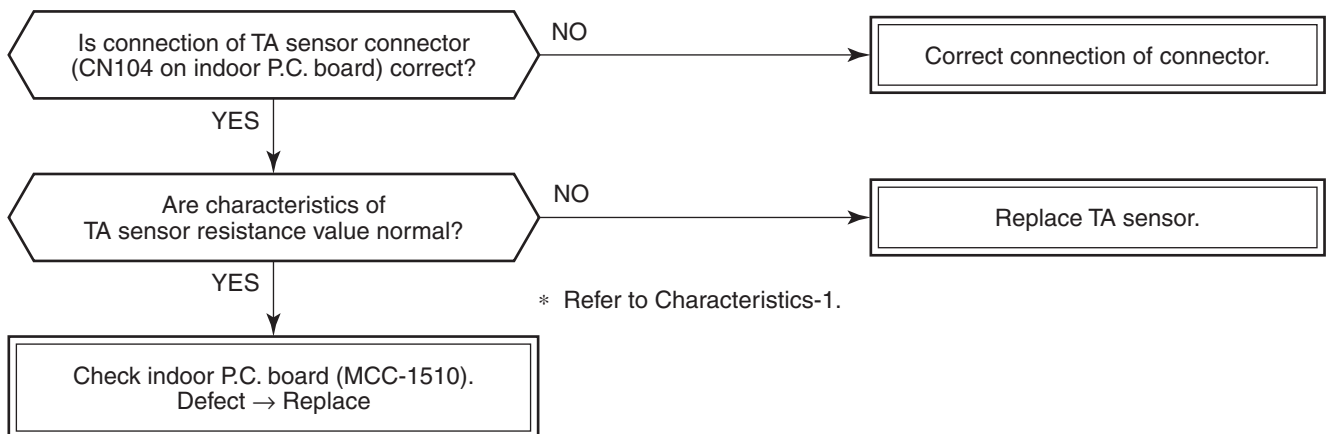

[P12 error]

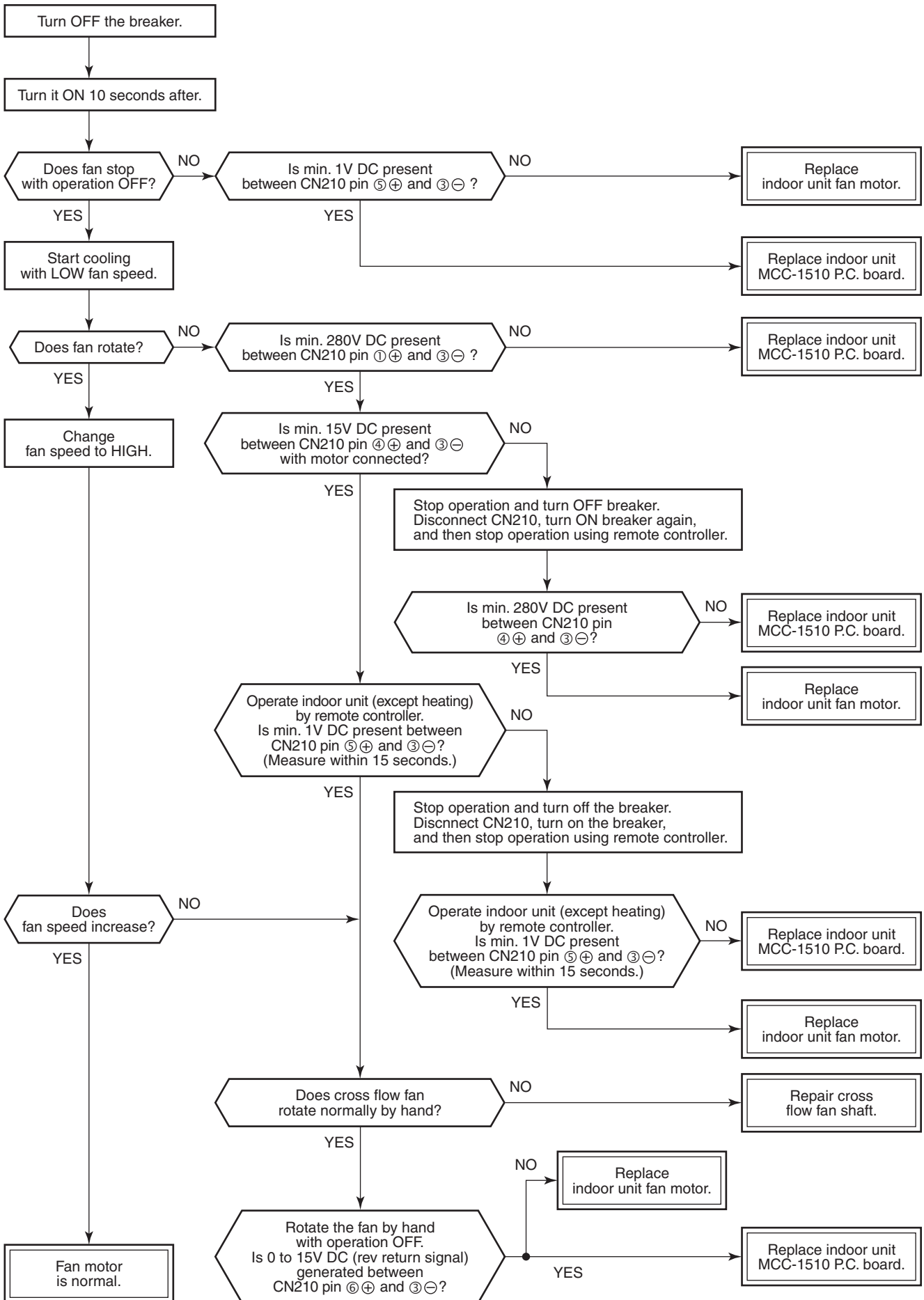

[F02 error]

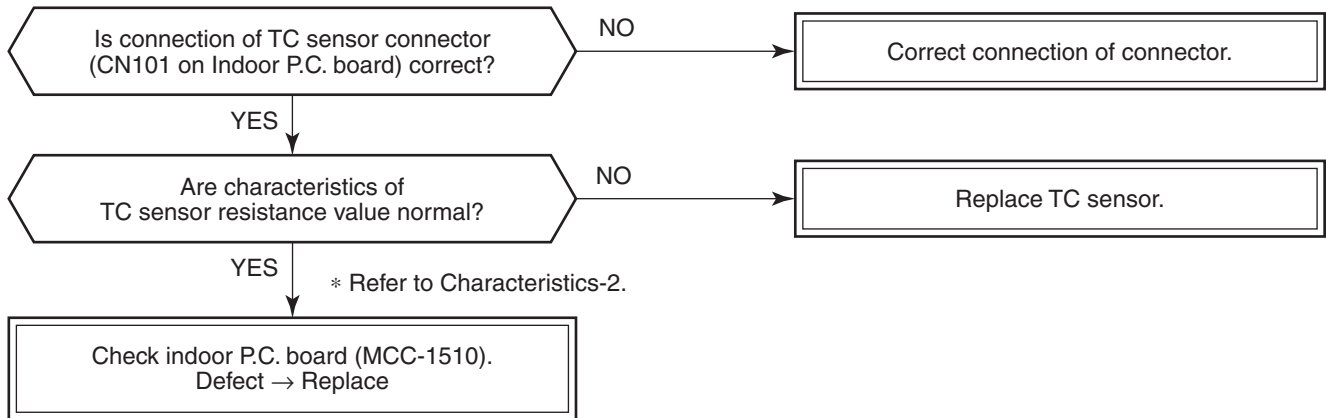

[F01 error]

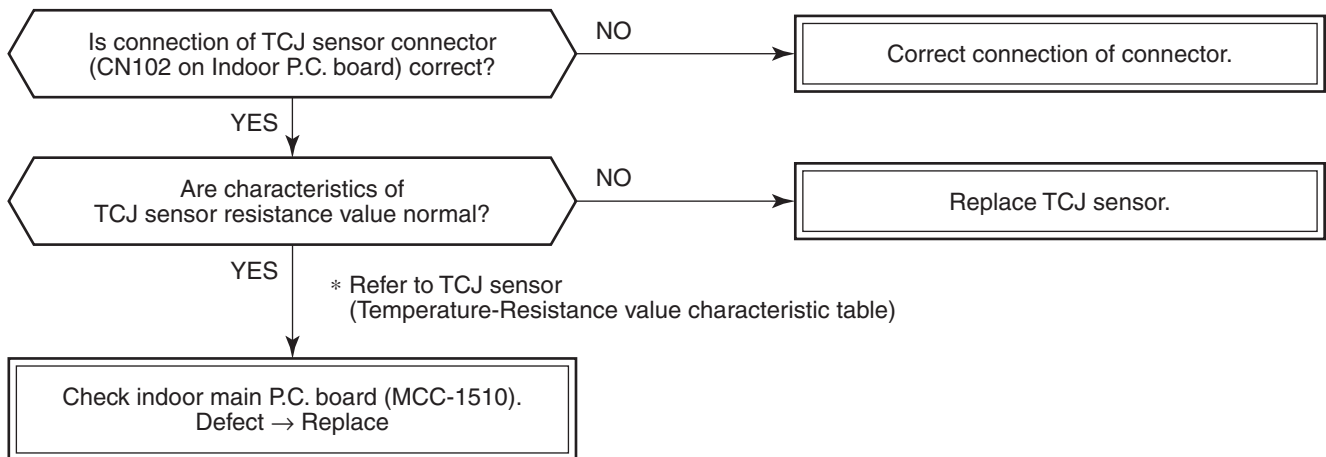

[F29 error]

This check code indicates a detection error of IC10 non-volatile memory (EEPROM) on the indoor unit P.C. board, which generated during operation of the air conditioner. Replace the service P.C. board.

* When EEPROM was not inserted when power supply turned on or when the EEPROM data read/write operation is impossible at all, the automatic address mode is repeated. In this time, [97 error] is displayed on the central controller.

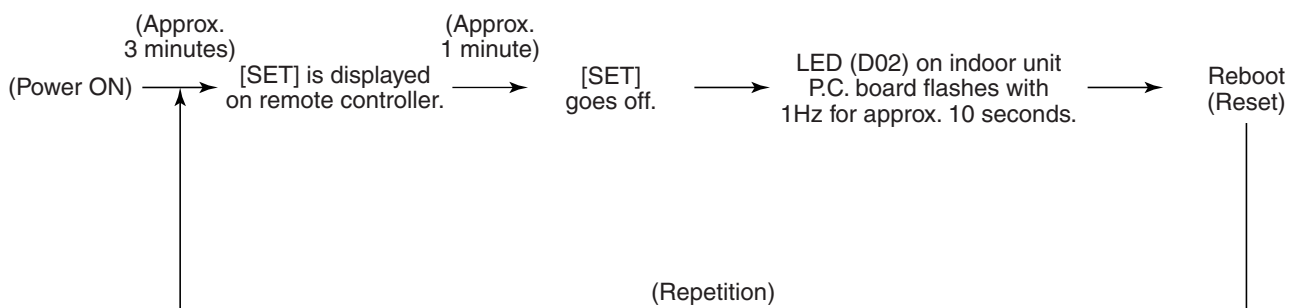

[P31 error] (Follower indoor unit)

When the header unit of a group operation detected [E03], [L03], [L07] or [L08] error, the follower unit of the group operation detects [P31 error] and then the unit stops.

There is no display of the CODE No. or alarm history of the remote controller. (In this model, the mode enters in automatic address set mode when the header unit detected [L03], [L07] or [L08] error.)

Temperature sensor

Temperature – Resistance value characteristic table

TA, TC, TCJ, TE, TS, TO sensors

TD, TL sensors

Representative value

Representative value

Temperature (°C)	Resistance value (kΩ)		
	(Minimum value)	(Standard value)	(Maximum value)
0	32.33	33.80	35.30
10	19.63	20.35	21.09
20	12.23	12.59	12.95
25	9.75	10.00	10.25
30	7.764	7.990	8.218
40	5.013	5.192	5.375
50	3.312	3.451	3.594
60	2.236	2.343	2.454
70	1.540	1.623	1.709
80	1.082	1.146	1.213
90	0.7740	0.8237	0.8761
100	0.5634	0.6023	0.6434

Temperature (°C)	Resistance value (kΩ)		
	(Minimum value)	(Standard value)	(Maximum value)
0	150.5	161.3	172.7
10	92.76	99.05	105.6
20	58.61	62.36	66.26
25	47.01	49.93	52.97
30	37.93	40.22	42.59
40	25.12	26.55	28.03
50	17.00	17.92	18.86
60	11.74	12.34	12.95
70	8.269	8.668	9.074
80	5.925	6.195	6.470
90	4.321	4.507	4.696
100	3.205	3.336	3.468

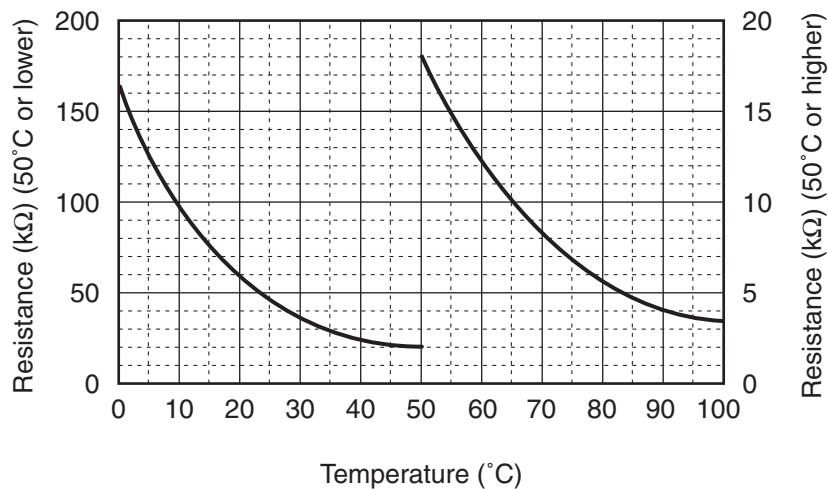
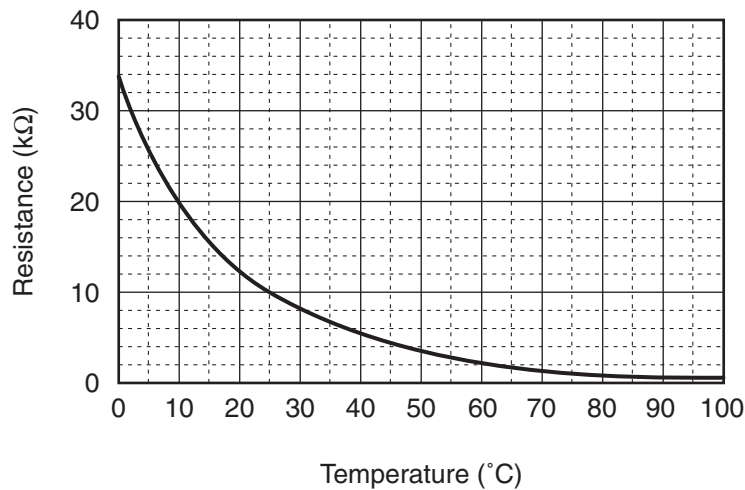

* As TH sensor (Outdoor unit heat sink temp. sensor) is incorporated in the outdoor control P.C. board, the resistance value cannot be measured.

9. REPLACEMENT OF SERVICE P.C. BOARD

Model type	P.C. board model	Label display on P.C. board
RAV-SM***KRT series	MCC-1510	04DD 03

[Requirement when replacing the service indoor P.C. board assembly]

In the non-volatile memory (Hereinafter said EEPROM, IC10) installed on the indoor P.C. board before replacement, the type and capacity code exclusive to the corresponding model have been stored at shipment from the factory and the important setup data such as refrigerant line /indoor unit /group address in (AUTO/MANUAL) mode have been stored at installation.

Replace the service indoor P.C. board assembly according to the following procedure.

After replacement, make sure that the indoor unit address is set correctly and also the refrigerant cycle is working correctly by test operation.

<Replacement procedure>

CASE 1

Before replacement, power of the indoor unit can be turned on and the setup data can be readout by the wired remote controller.

Read EEPROM data (see □1 in Page 61)



Replace service P.C. board & power ON (see □2 in Page 62)



Write the read data to EEPROM (see □3 in Page 64)



Power reset

(If in group operation, reset the power for all indoor units which are connected to the remote controller.)

CASE 2

Before replacement, the setup data can not be read out by the wired remote controller.

Replace service P.C. board & power ON (see □2 in Page 62)



Write the data such as “option input selection” setup to EEPROM (see □3 in Page 64)
(According to the customers' information)



Power reset

□1 Readout of the setup data from EEPROM

(Data in EEPROM contents, which have been changed at the local site, are read out together with data in EEPROM set at shipment from the factory.)

1. Push **SET**, **CL** and **TEST** buttons of the remote controller at the same time for 4 seconds or more. **1**
(Corresponded with No. in Remote controller as shown below picture)
* When group operation, the header indoor unit address is displayed at the first time. In this time, the CODE No. (DN) **10** is displayed.
The fan of the second indoor unit operates and the louver starts swinging if any.
2. Every pushing [Unit, Louver **UNIT LOUVER**] button, the indoor unit address in the group are displayed successively. **2**
Specify the indoor unit No. to be replaced.
3. Using the set temperature **▼** / **▲** buttons, the CODE No. (DN) can be moved up and down one by one. **3**
4. First change the CODE No. (DN) from **10** to **01**. (Setting of filter sign lighting time)
Make a note of the SET DATA displayed in this time.
5. Next change the CODE No. (DN) using the set temperature **▼** / **▲** buttons.
Also make a note of the SET DATA.
6. Repeat item 5. and made a note of the important SET DATA as shown in the below table.
* **01** to **AA** are provided in the CODE No. (DN). On the way of operation, CODE No. (DN) may skip.
7. After finishing making a note, push **TEST** button to return to the usual stop status. **4**
(Approx. 1 minute is required to be able to use the remote controller.)

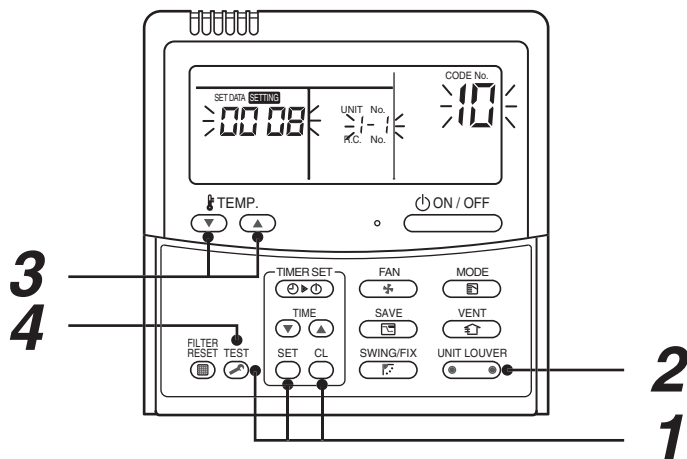

Minimum requirements for CODE No.

CODE No. (DN)	Contents
11	Indoor unit capacity
12	Refrigerant line address
13	Indoor unit address
14	Group address



Capacity of the indoor unit is necessary to set the revolutions of the fan.

□2 Replacement of service P.C. board

1. Replace the P.C. board with a service P.C. board.

In this time, setting of jumper line (cut) or setting of DIP switch on the former P.C. board should be reflected on the service P.C. board.

Refer to the following table about DIP switch setting and drawing of P.C. board parts layout.

2. According to the system configuration, turn on power of the indoor unit with any method in the following items.
 - 1) In case of single (individual) operation. Turn on power supply.
 - A) Wait for completion of automatic address setup mode (Required time: Approx. 5 minutes) and then proceed to **□3**. (Refrigerant line address = 1, Indoor unit address = 1, Group address = 0 (Individual) are automatically set.)
 - B) Push ,  and  buttons of the remote controller at the same time for 4 seconds or more (**7** operation), Interrupt the automatic address setup mode, and then proceed to **□3**.
 - 2) In case of group operation. Turn on power of the indoor unit of which P.C. board has been replaced with the service P.C. board with any method in the following items.
 - A) Turn on power of the replaced indoor unit only.
(However, the remote controller is also connected. Otherwise **□3** operation cannot be performed.)
Same as A) and B) in item 1).
 - B) Turn on power of the multiple indoor units including replaced indoor unit.
 - Only a set of twin combination system
 - For all units in the group

Wait for completion of automatic address setup mode (Required time: Approx. 5 minutes) and then proceed to **□3**.

* The header indoor unit of a group may change by setup of automatic address.

The refrigerant line address/indoor unit address of the replaced indoor unit are automatically set to the vacant addresses except addresses belonging to other indoor units which have not been replaced.

It is recommended to make a note that the refrigerant line which includes the corresponding indoor unit and that the corresponding indoor unit is master or sub in the group control.

P.C. board parts layout drawing

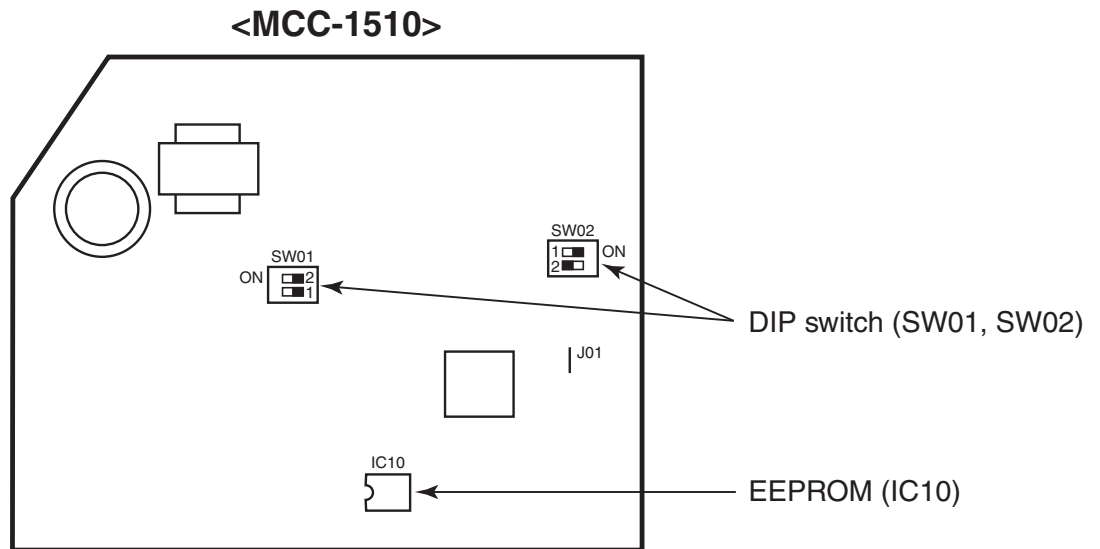

Method of DIP switch setting

		Selected content	RAV-SM *** KRT series	At shipment
SW01	Bit 1	Terminator resistor (for central control)	* 1	OFF (Without terminator)
	Bit 2	Remote controller A/B selection	* 1	OFF (A selection)
SW02	Bit 1	Custom / Multi model selection	OFF	OFF (Custom model)
	Bit 2	No use	OFF	OFF

*1 : Match to set up contents of P.C. board before replacement.

□3 Writing of the setup contents to EEPROM

(The contents of EEPROM installed on the service P.C. board have been set up at shipment from the factory.)

1. Push ^{SET}○, ^{CL}○ and ^{TEST}⊗ buttons of the remote controller at the same time for 4 seconds or more. **1**
 (Corresponded with No. in Remote controller as shown below picture) (The UNIT No. *ALL* is displayed.)
 In this time, the CODE No. (DN) *10* is displayed.
 The fan of the indoor unit operates and the louver starts swinging if any.
 2. Using the set temperature [▼] / [▲] buttons, the CODE No. (DN) can be moved up and down one by one. **2**
 3. First set the capacity of the indoor unit.
 (Setting the capacity writes the data at shipment from the factory in EEPROM.)
 - 1) Using the set temperature [▼] / [▲] buttons, set *11* to the CODE No. (DN). **2**
 - 2) Using the timer time [▼] / [▲] buttons, set the capacity. **3**
 - 3) Push ^{SET}○ button. (OK when the display goes on.) **4**
 - 4) Push ^{TEST}⊗ button to return to usual stop status. **5**
 (Approx. 1 minute is required to start handling of the remote controller.)
 4. Next write the contents that have been written at the installation such as the address data into EEPROM.
 Repeat the above procedure 1.
 5. Using the set temperature [▼] / [▲] buttons, set *01* to the CODE No. (DN). **2**
 (Setup of lighting time of filter sign)
 6. The contents of the displayed SET DATA in this time should be agreed with the contents in the previous memorandum in □1.
 - 1) If data disagree, change the displayed SET DATA to that in the previous memorandum by the timer time [▼] / [▲] buttons, and then push ^{SET}○ button. (OK when the display goes on.)
 - 2) There is nothing to do when data agrees.
 7. Using the set temperature [▼] / [▲] buttons, change the CODE No. (DN).
 As same as the above 6., check the contents of the SET DATA and then change them to data contents in the previous memorandum in □1.
 8. Then repeat the procedure 6. and 7.
 9. After completion of setup, push ^{TEST}⊗ button to return the status to the usual stop status. **5**
 In a group operation, turn off the power supply once, return the group wires between indoor units and CN41 connectors as before, and then turn on power of all the indoor units.
 (Approx. 1 minute is required to be able to use of the remote controller.)
 * *01* to *AA* are provided in the CODE No. (DN). On the way of operation, CODE No. (DN) may skip.
- When data has been changed by mistake and ^{SET}○ button has been pushed, the data can be returned to the data before change by pushing ^{CL}○ button if the CODE No. (DN) was not yet changed.

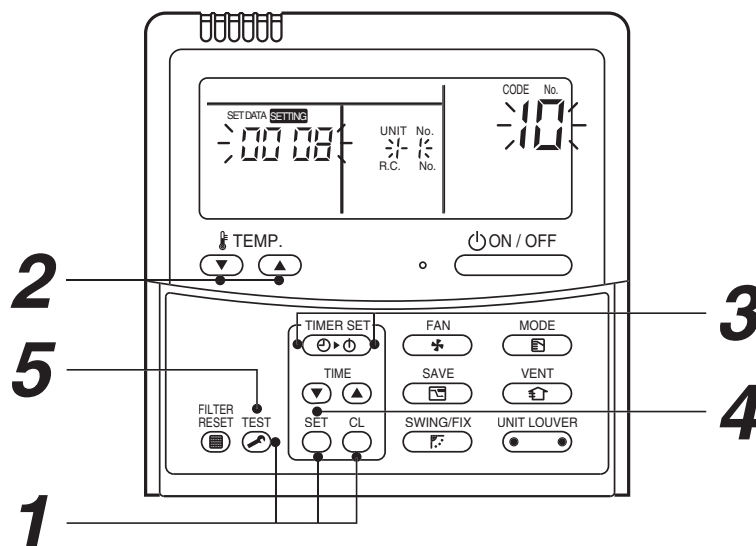

CODE No. (DN) table (Please record the objective unit data at field)

DN	Item	Memo	At shipment
01	Filter sign lighting time		0001: 150 hour
02	Dirty state of filter		0000: Standard
03	Central control address		0099: Unfixed
06	Heating suction temp shift		0002: +2°C
0C	PRE-DEF indication selection		0000: Standard
0d	Cooling auto mode existence		0001: No auto mode cooling/heating
0F	Cooling only		0000: Heat pump
10	Type	Be sure to set as 0008	0008: High wall type
11	Indoor unit capacity (See below table)		According to capacity type
12	Refrigerant line address		0099: Unfixed
13	Indoor unit address		0099: Unfixed
14	Group address		0099: Unfixed
1E	Temp difference of automatic cooling/heating selecting control points		0003: 3deg (Ts ± 1.5)
28	Auto restart		0001: Provided
2A	Option input selection (CN80)		0002: External emergency input
2b	Thermo output selection (T10 ③)		0000: Thermo ON
2E	Input selection (T10 ①)		0000: Operation input
32	Sensor selection		0000: Available
60	Timer set (Wired remote controller)		0000: Available
69	Louver selection of cooling		0000: Standard

Indoor unit capacity (CODE No. [11])

SET DATA	Model
0001*	Invalid
0009	56
0012	80

* Initial value of EEPROM installed on the supplied service P.C. board

10. SETUP AT LOCAL SITE AND OTHERS

10-1. Test Run Setup on Remote Controller

<Wired remote controller>

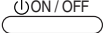
- When pushing  button on the remote controller for 4 seconds or more, "TEST" is displayed on LC display. Then push  button.
 - "TEST" is displayed on LC display during operation of Test Run.
 - During Test Run, temperature cannot be adjusted but air volume can be selected.
 - In heating and cooling operation, a command to fix the Test Run frequency is output.
 - Detection of error is performed as usual. However, do not use this function except case of Test Run because it applies load on the unit.
- Use either heating or cooling operation mode for [TEST].



NOTE

The outdoor unit does not operate after power has been turned on or for approx. 3 minutes after operation has stopped.



- After a Test Run has finished, push  button again and check that [TEST] on LC display has gone off. (To prevent a continuous test run operation, 60 minutes timer release function is provided to this remote controller.)

<Temporary button>

• Checking wiring and piping of indoor/outdoor units

- Push  [TEMPORARY] button for 10 seconds.
The unit enters forcible cooling mode with a sound "pi". COOL operation starts forcibly about 3 minutes later. Check whether cool air is discharged. If COOL operation does not start, recheck the wiring.
- Push  [TEMPORARY] for about 1 second to stop trial operation.
The vertical airflow louver closes and the operation stops.

• Checking signal transmission from remote controller

- Push [ON/OFF] on the remote controller to check for normal operation using remote controller.
 - To enter AUTO mode, push  [TEMPORARY] once for about 1 second.
For forcible cooling, push  [TEMPORARY] for 10 seconds or more.
 - COOL operation specified by remote controller may not start depending on temperature conditions. Use forcible cooling operation to check wiring and piping of indoor/outdoor unit.

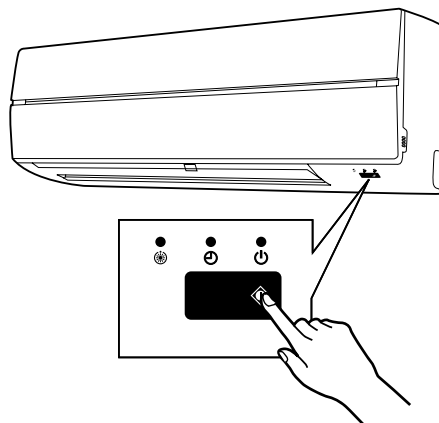

10-2. Forced Defrost Setup of Remote Controller (For wired remote controller only)**(Preparation in advance)**

1 Push  +  +  buttons simultaneously for 4 seconds or more on the remote controller. (Push buttons while the air conditioner stops.)

The first displayed unit No. is the master indoor unit address in the group control.

2 Every pushing  button, the indoor unit No. in the group control is displayed one after the other.

Select a main indoor unit (outdoor unit is connected) which is to be defrosted. In this time, fan and louver of the selected indoor unit operate.

3 Using the set temperature  buttons, specify the CODE No. (DN) 8C.

4 Using the timer time  buttons, set time to data 0001. (0000 at shipment)

5 Push  button. (OK if indication lights)

6 Pushing  button returns the status to the normal stop status.

(Practical operation)

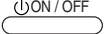
- Push ON/OFF  Key.
- Select the HEAT mode.
- After while, the forced defrost signal is sent to the outdoor unit and then the outdoor unit starts defrost operation. (The forced defrost operation is performed for Max. 12 minutes.)
- After defrost operation finished, the operation returns to the heating operation.

To execute the defrost operation again, start procedure from above item 1 .

(If the forced defrost operation was executed once, setting of the above forced defrost operation is cleared.)

10-3. LED Display on P.C. Board**1. D02 (Red)**

- Lights up by the control of main microcomputer when the indoor unit is powered ON.
- Flashes at intervals of 1 second (0.5-second ON and OFF) when EEPROM is not mounted or write error occurs.
- Flashes at intervals of 10 seconds (5-second ON and OFF) in the DISP mode. (CN72 short-circuited at power ON)
- Flashes at intervals of 2 seconds (1-second ON and OFF):
Applicable unit in the EEPROM setting (address, function selection, ect.) mode.

2. D203 (Red)

- Lights up by hardware control when power is supplied to remote controller.

10-4. Function Selection Setup (Wired Remote Controller Only)

<Procedure> Perform setting while the air conditioner stops.

1 Push **TEST** + **SET** + **CL** buttons simultaneously for 4 seconds or more.

The first displayed unit No. is the header indoor unit address in the group control.
In this time, fan and louver of the selected indoor unit operate.



2 Every pushing **UNIT LOUVER** button (button at left side), the indoor unit No. in the group control is displayed one after the other. In this time, fan and louver of the selected indoor unit only operate.



3 Using the set temperature **TEMP.** buttons, specify the CODE No. (DN).



4 Using the timer time **TIME** buttons, select the SET DATA.



5 Push **SET** button. (OK if indication lights)

- To change the selected indoor unit, proceed to Procedure **2**.
- To change CODE No. to be set up, proceed to Procedure **3**.



6 Pushing **TEST** button returns the status to the normal stop status.

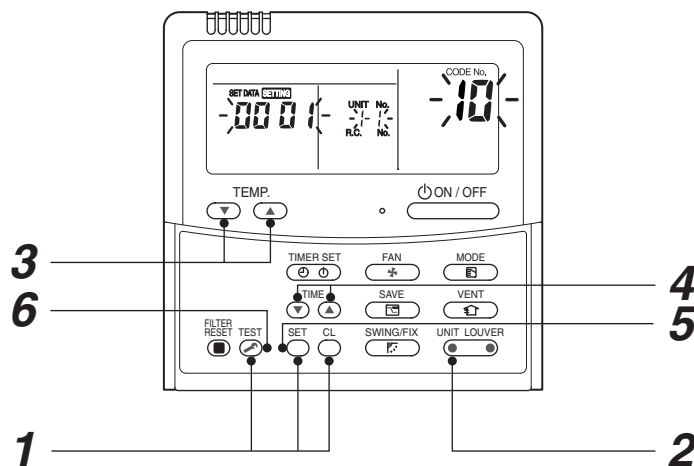

<Operation procedure>

1 → 2 → 3 → 4 → 5 → 6 END

Function selection CODE No. (DN) list

CODE No. (DN)	Item	Contents		At shipment from factory
01	Filter sign lighting time	0000: None 0002: 2500H 0004: 10000H	0001: 150H 0003: 5000H 0005: Clogging sensor used	0001: 150H
02	Filter stain level	0000: Standard 0001: Heavy stain (Half of standard time)		0000: Standard
03	Central control address	0001: No.1 unit 0099: Undecided	to 0064: No.64 unit	0099: Undecided
06	Heating suction temp. shift	0000: No shift 0002: +2°C 0003: +3°C	to 0001: +1°C 0010: +10°C (Up to +6 is recommended.)	0003: +3°C 0002: +2°C
0C	Preparing indication selection	0000: Preparing indicated	0001: No indication	0000: Preparing indicated
0F	Cooling-only	0000: Heat pump 0001: Cooling only (No display for [AUTO] [HEAT])		0000: Heat pump
10	Type	0001: 4-way air discharge cassette 0004: Concealed duct 0007: Under ceiling	0008: High wall	0008: High wall
11	Indoor unit capacity	0000: Undecided	0001 to 0034	According to capacity type
12	Line address	0001: No.1 unit	to 0030: No.30 unit	0099: Undecided
13	Indoor unit address	0001: No.1 unit	to 0064: No.64 unit	0099: Undecided
14	Group address	0000: Individual 0002: Follower unit in group	0001: Master unit in group	0099: Undecided
1E	In automatic cooling/heating, temp. width of cool → heat, heat → cool mode selection control point	0000: 0 deg	to 0010: 10 deg (Cool/heat are reversed with ± (Data value) / 2 against the set temperature)	0003: 3 deg (Ts±1.5)
28	Auto restart	0000: None	0001: Provided	0000: None
2A	Selection of option / error input (CN80)	0000: Filter input 0002: External alarm input	0001: Alarm input (Air cleaner, etc.)	0002: External alarm input
2b	Selection of thermostat output (T10 ③)	0000: Indoor thermostat ON 0001: ON receiving output of outdoor compressor		0000: Thermostat ON
2E	Selection of HA (T10 ①) terminal	0000: Normal (JEMA) 0002: Fire alarm input	0001: Card input (Forgotten to be off)	0000: Normal (HA terminal)
31	Fan (Single operation)	0000: Impossible	0001: Possible	0000: Impossible
32	Sensor selection	0000: Body TA sensor 0001: Remote controller sensor		0000: Body sensor
60	Timer setting (Wired remote controller)	0000: Operable	0001: Operation prohibited	0000: Operable
69	Louver setting for cooling	0000: Normal	0001: Down allowed	0000: Normal
86	Correction of feeling of strong heating	0000: Not provided	0001: Provided	0000: Not provided
C2	Power saving (Current demand X% to outdoor unit)	0050 : 50% to 0100 : 100%		0075 : 75%

* Restriction ratio setting for save operation (DODE No. (DN) [C2]) can be set/changed from the normal CODE No. (DN) setup (Detail CODE No. (DN) setup).

10-5. Wiring and Setting of Remote Controller Control

2-remote controller control (Controlled by 2 remote controllers)

This control is to operate 1 or multiple indoor units are operated by 2 remote controllers.
(Max. 2 remote controllers are connectable.)

• When connected 2 remote controllers operate an indoor unit

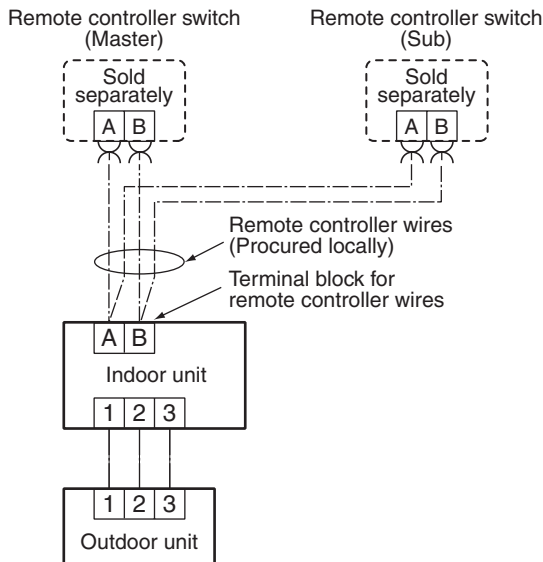

(Setup method)

One or multiple indoor units are controlled by 2 remote controllers.
(Max. 2 remote controllers are connectable.)

<Wired remote controller>

How to set wired remote controller as sub remote controller

Change DIP switch inside of the rear side of the remote controller switch from remote controller master to sub.

Remote controller (Inside of the rear side)

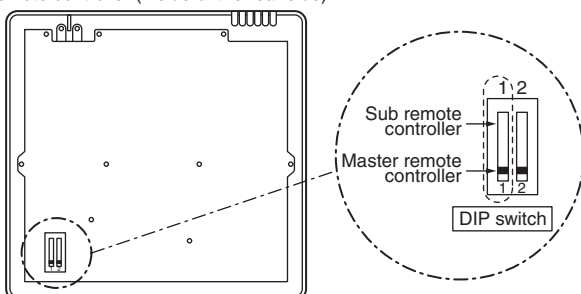

[Operation]

1. The operation contents can be changed by Last-push-priority.
2. Use a timer on either Master remote controller or Sub remote controller.

<Wireless remote controller A-B selection>

Using 2 wireless remote controllers for the respective air conditioners, when the 2 air conditioners are closely installed.

Wireless remote controller B setup

1. Push [TEMPORARY] button on the indoor unit to turn the air conditioner ON.
2. Point the wireless remote controller at the indoor unit.
3. Push and hold **CHK** ● button on the wireless remote controller by the tip of the pencil.
"00" will be shown on the display.
4. Push **MODE** ● during pushing **CHK** ● .
"B" will be shown on the display and "00" will be disappear and the air conditioner will turn OFF.
The wireless remote controller B is memorized.

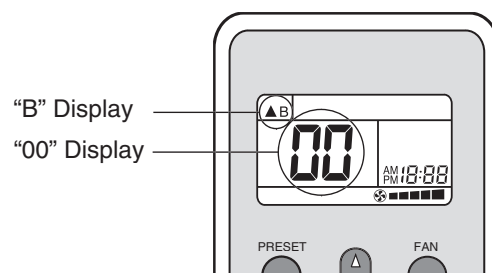

NOTE

- Repeat above step to reset wireless remote controller to be A.
- The wireless remote controllers do not display "A".
- The factory default of the wireless remote controllers is "A".

10-6. Monitor Function of Remote Controller Switch

■ Calling of sensor temperature display

<Contents>

Each data of the remote controller, indoor unit and outdoor unit can be understood by calling the service monitor mode from the remote controller.

<Procedure>

- 1 Push  +  buttons simultaneously for 4 seconds to call the service monitor mode.**

The service monitor goes on, the master indoor unit No. is displayed at first and then the temperature of CODE No.  is displayed.



- 2 Push temperature set   buttons and then change the CODE No. of data to be monitored.**

The CODE No. list is shown below.

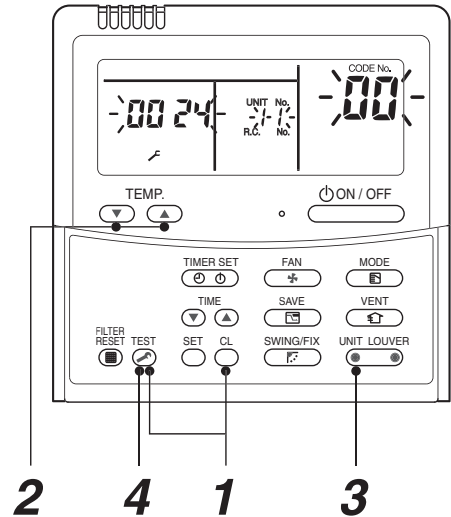

<Operation procedure>

1 → 2 → 3 → 4

↑
Returned to usual display

	CODE No.	Data name
Indoor unit data	00	Room temperature under control *1
	01	Room temperature (Remote controller)
	02	Indoor suction temperature (TA)
	03	Indoor heat exchanger (Coil) temperature (TCJ)
	04	Indoor heat exchanger (Coil) temperature (TC)

	CODE No.	Data name
Outdoor unit data	60	Outdoor heat exchanger (Coil) temperature (TE)
	61	Outside temperature (TO)
	62	Compressor discharge temperature (TD)
	63	Compressor suction temperature (TS)
	65	Heat sink temperature (TH)

*1 Header indoor unit only under group control.



- 3 Push  button to select the indoor unit to be monitored. Each data of the indoor unit and its outdoor units can be monitored.**



- 4 Pushing  button returns the status to the usual display.**

10-7. Calling of error history

<Contents>

The error contents in the past can be called.

<Procedure>

1 Push **SET** + **TEST** buttons simultaneously for **4 seconds or more** to call the service check mode.

Service Check goes on, the **CODE No. 01** is displayed, and then the content of the latest alarm is displayed. The number and error contents of the indoor unit in which an error occurred are displayed.

2 In order to monitor another error history, push the set temperature **▼** / **▲** buttons to change the error history No. (CODE No.).

CODE No. **01** (Latest) → CODE No. **04**(Old)

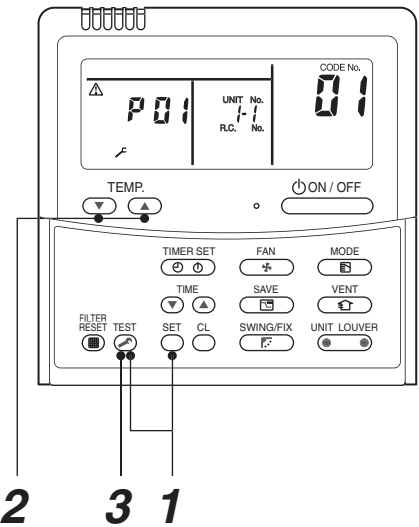

<Operation procedure>

1 → 2 → 3

Returned to usual display

NOTE

4 error histories are stored in memory.

3 Pushing **TEST** button returns the display to usual display.

REQUIREMENT

Do not push **CL** button, otherwise all the error histories of the indoor unit are deleted.

10-8. Group control operation

In a group control, operation of maximum 8 indoor units can be controlled by a remote controller. The indoor unit connected with outdoor unit controls room temperature according to setting on the remote controller.

<System example>

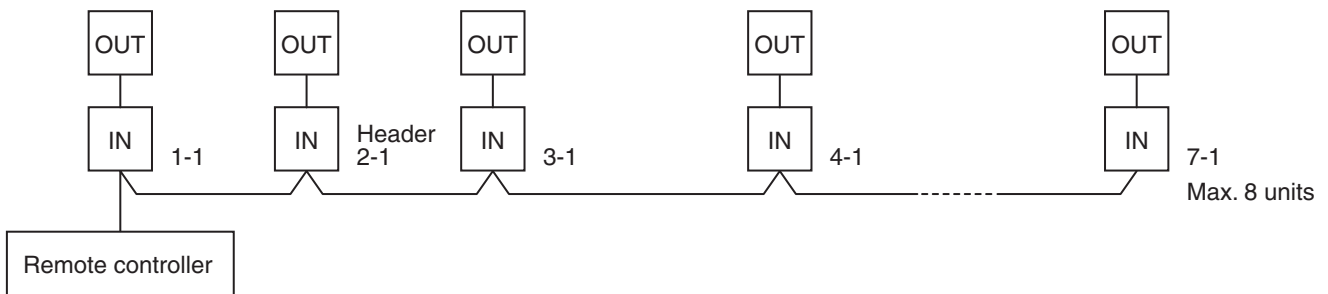

1. Display range on remote controller

The setup range (Operation mode/Air volume select/Setup temp) of the indoor unit which was set to the header unit is reflected on the remote controller.

2. Address setup

Turn on power of the indoor unit to be controlled in a group within 3 minutes after setting of automatic address.

If power of the indoor unit is not turned on within 3 minutes (completion of automatic address setting), the system is rebooted and the automatic address setting will be judged again.

- 1) Connect Indoor/Outdoor connecting wires.
- 2) Check line address/indoor address/group address of the unit one by one.
- 3) The unit No. (line/indoor gout address) which have been set once keep the present status as a rule if the unit No. is not duplicated with one of another unit.

■ Indoor unit power-ON sequence

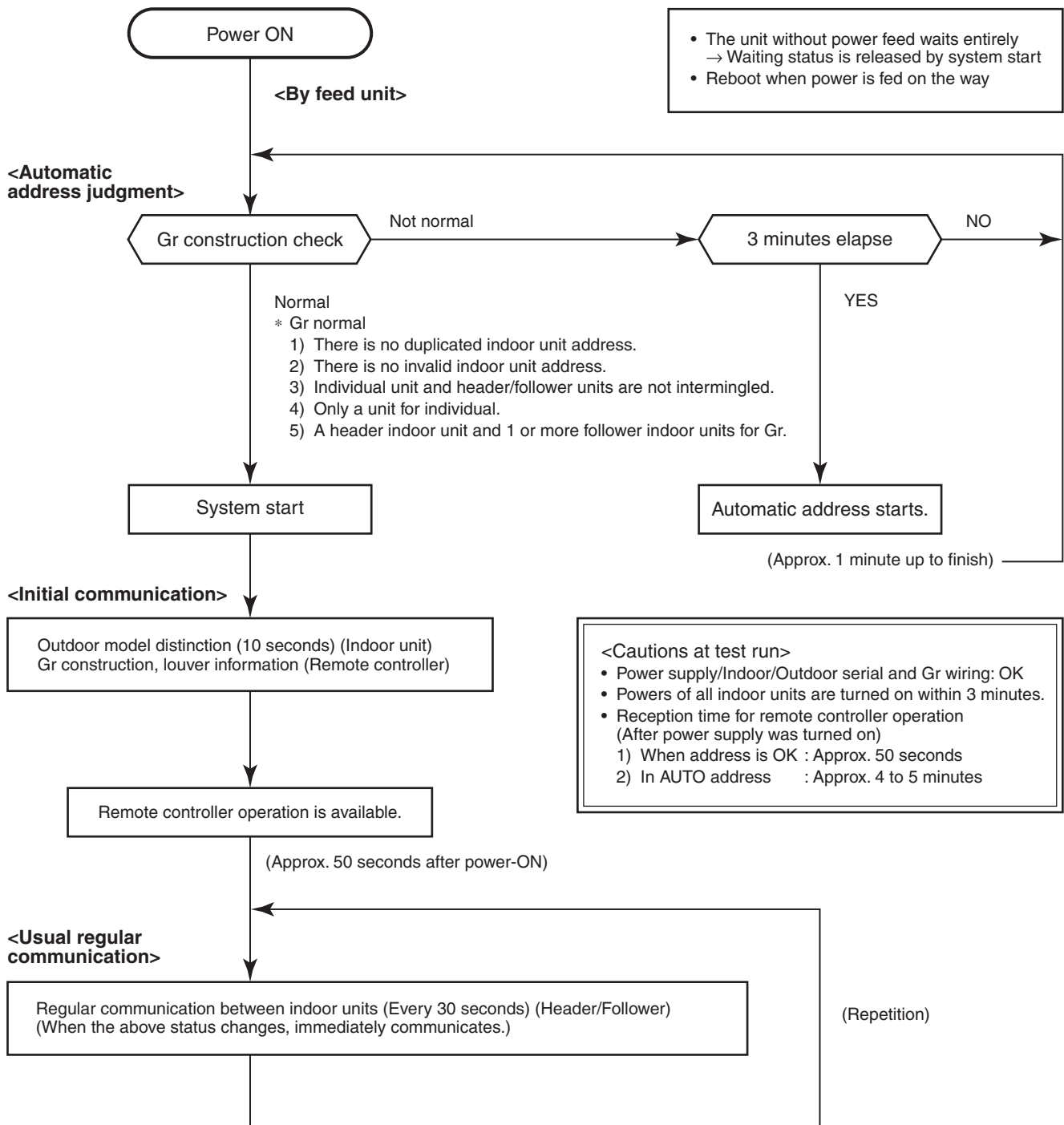

- In a group operation, if the indoor unit which was fed power after judgment of automatic address cannot receive regular communication from the header unit and regular communication on identical pipe within 120 seconds after power was turned on, it reboots (system reset).
→ The operation starts from judgment of automatic address (Gr construction check) again.
(If the address of the header unit was determined in the previous time, the power fed to the header unit and reboot works, the header unit may change though the indoor unit line address is not changed.)

10-8. TCC-LINK Central Control

10-8-1 Functions

Connect an indoor unit to the TCC-LINK central controller.

10.8.2 Connection Diagram

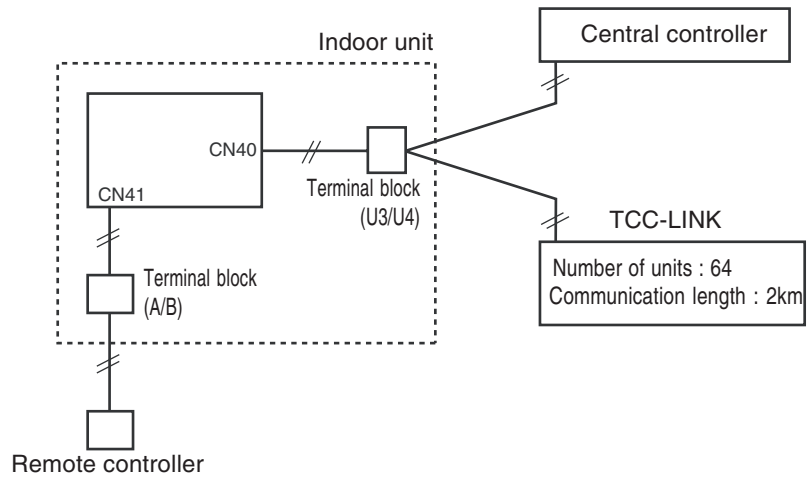

10.8.3 Wiring Specifications

Number of wires	Size	Specification
2	Up to 1000 m: 1.25 mm ² stranded wires Up to 2000 m: 2.0 mm ² stranded wires	MVVS

- A 2-wire non-polarity cable is used.
- The cable length depends on each central control system.
- When used in a system including multiple air conditioners, the length includes the length of all wires between indoor and outdoor units on the side of multiple air conditioners.
- Use 2-wire shield cable (MVVS) to protect from noise.
- Joint shield wire between indoor units by closed-end terminating, and leave its end open with insulation processing. Make one-point grounding at the indoor unit side. Set the terminating resistors.

(Central control for custom indoor units only)

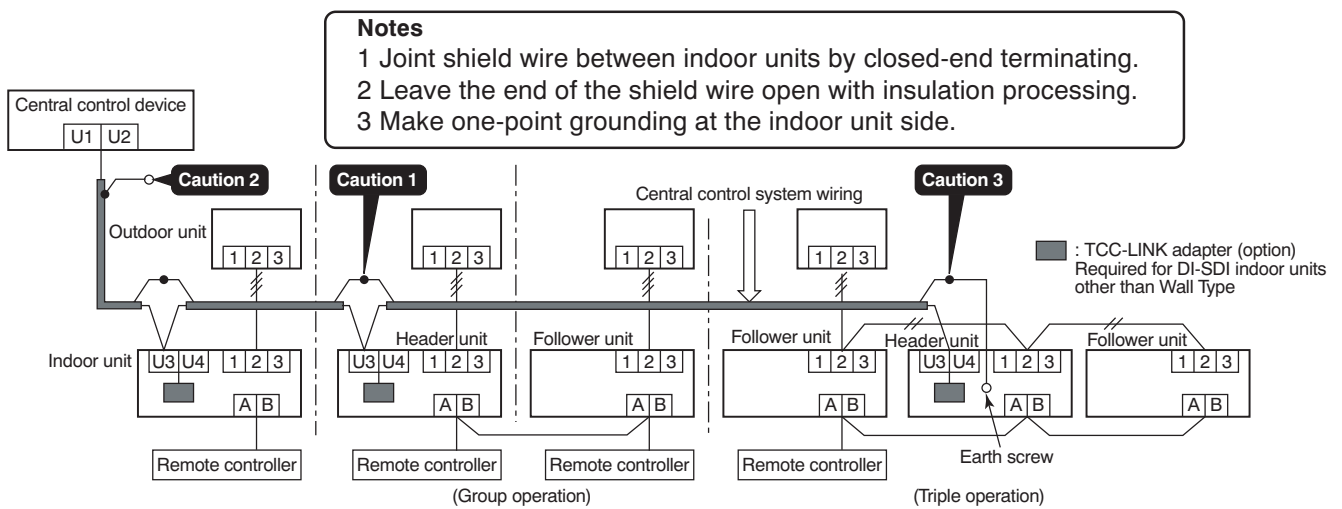

10.8.4 Setting Onboard Switches

Setting of terminating resistors is necessary for central control of custom indoor units only.

- Use SW01 to set terminating resistors.
- **Set terminating resistors for the indoor unit only with the smallest refrigerant line address.**

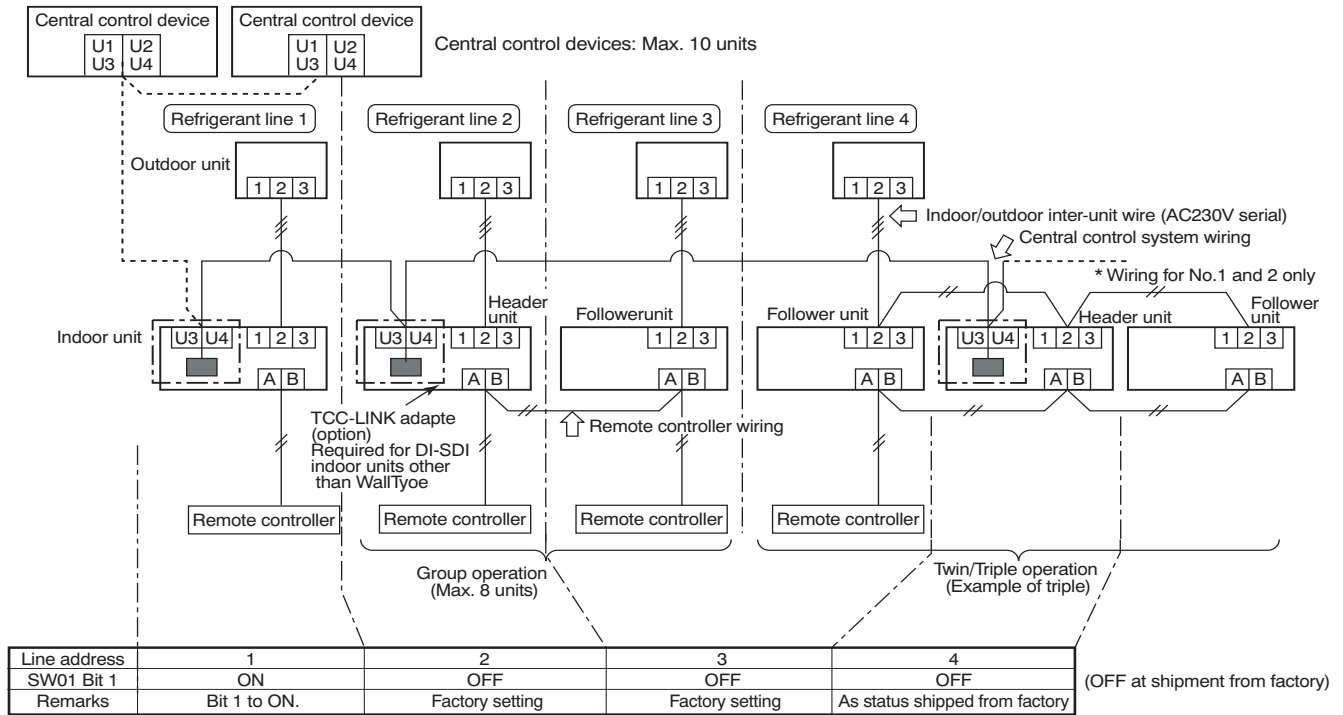

10.8.5 Onboard Switch Setting Procedure

1. Detach the front panel.
2. Remove the drain guide and disconnect TCJ sensor.

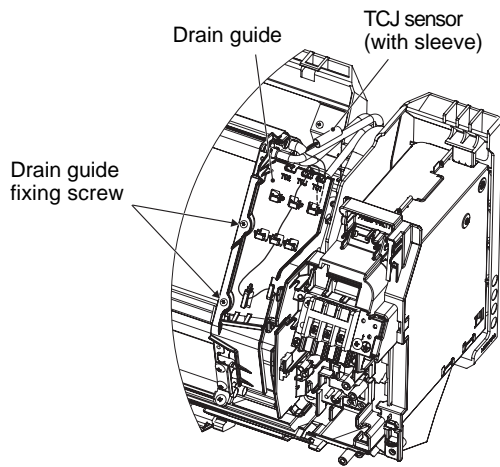

3. Remove the earth wire, TC sensor, and motor lead (louver motor, fan motor).

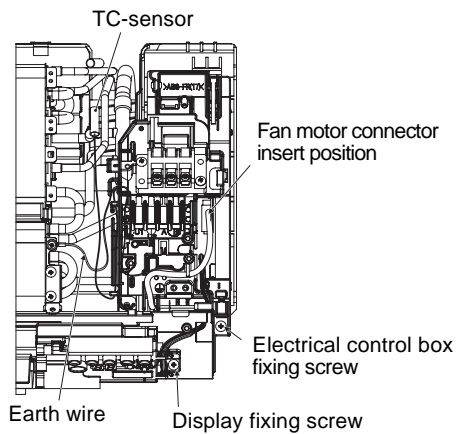

4. Remove the screws and detach the electrical control box.

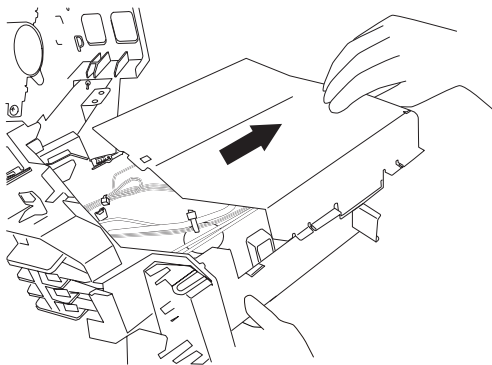

5. Detach the electric parts cover, and set SW01 bit 1 to ON.
Do not touch bit 2 as it is for other setting.

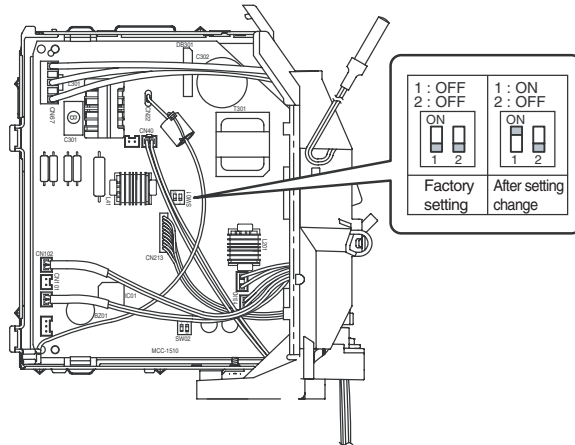

6. Install the removed parts by reversing steps 1 to 6.
(Insert the sensors and motor leads firmly into their correct positions.)

10.8.6 Setting Addresses

Overview

To connect DI-SDI air conditioners to the TCC-LINK central control system for central control/monitoring, addresses of connected indoor units must be set in the following procedure.

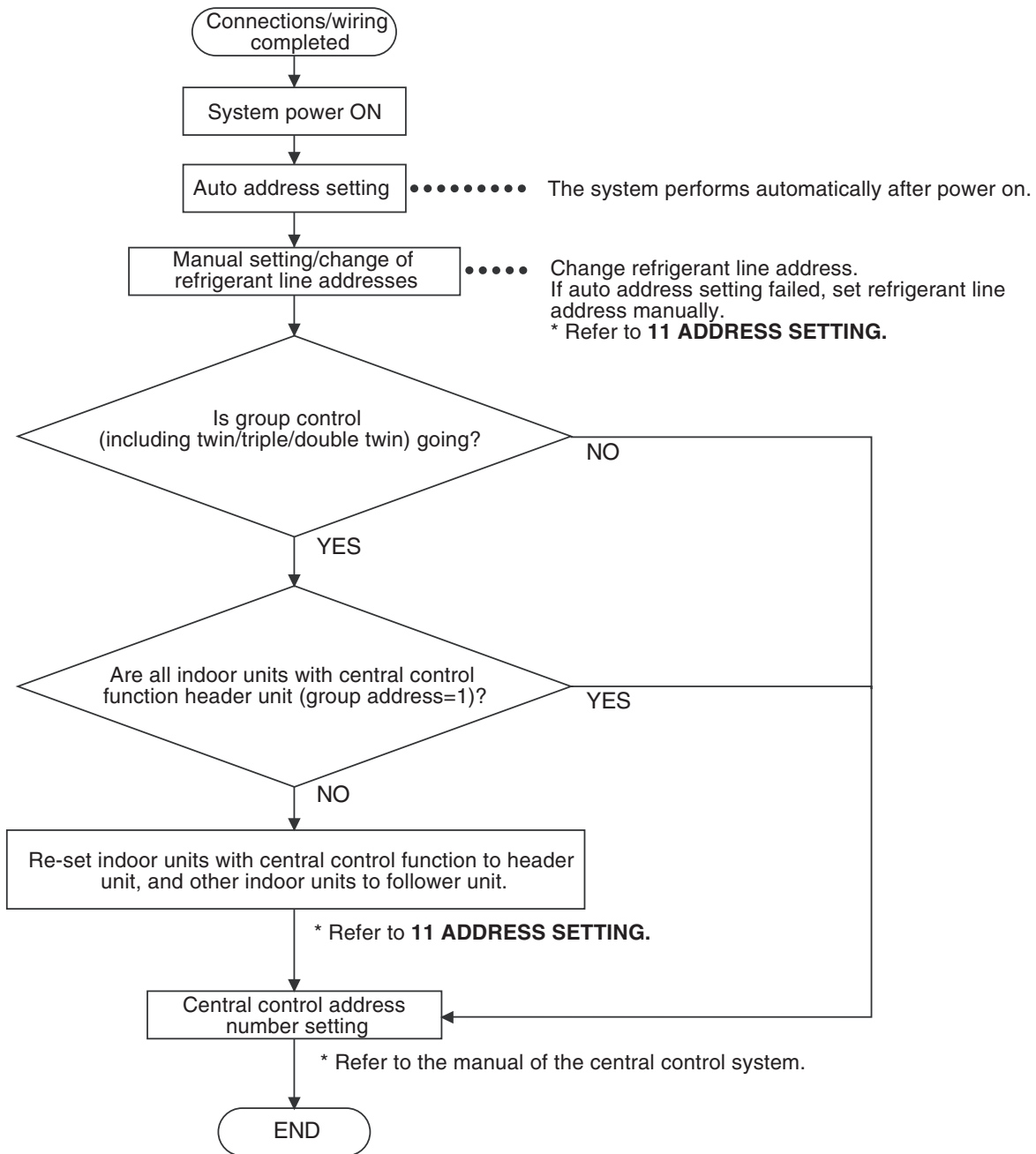

(1) Manual setting/change of indoor unit refrigerant line addresses

[In the case of 29 refrigerant systems or less (when multiple air conditioners are included, their number of refrigerant systems is also included)]

Refrigerant address “1” is assigned to all indoor units except for group control by the auto address setting after system power on.

Therefore, change refrigerant line address of each refrigerant system using the wired remote controller.

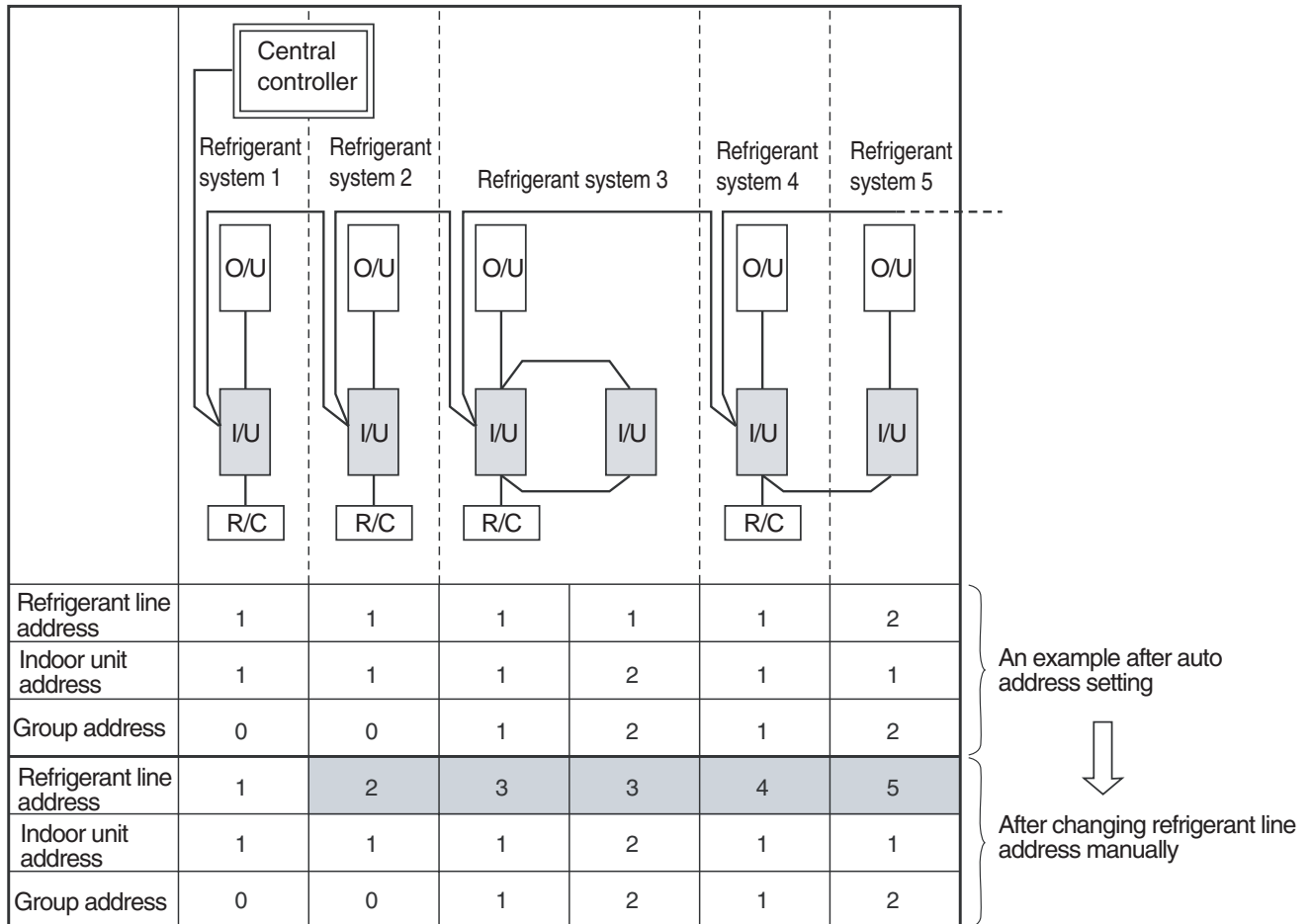

* For changing/setting refrigerant line addresses by wired remote controller, refer to **11. ADDRESS SETTING.**

* Refrigerant line address must be unique for each refrigerant system.

To perform central control in combination of SMMS and DI•SDI air conditioners, set refrigerant line addresses different from those of SMMS.

(2) Manual setting/change of indoor unit refrigerant line addresses

[In the case of 30 refrigerant systems or more (when multiple air conditioners are included, their number of refrigerant systems is also included)]

Regarding refrigerant systems up to No. 29, manual setting/change is the same as that on the previous page.

- Refrigerant address “1” is assigned to all indoor units except for group control by the auto address setting after system power on. Therefore, change refrigerant line address of each refrigerant system using the wired remote controller.
- Also change indoor unit addresses so as to avoid duplication of indoor unit numbers.

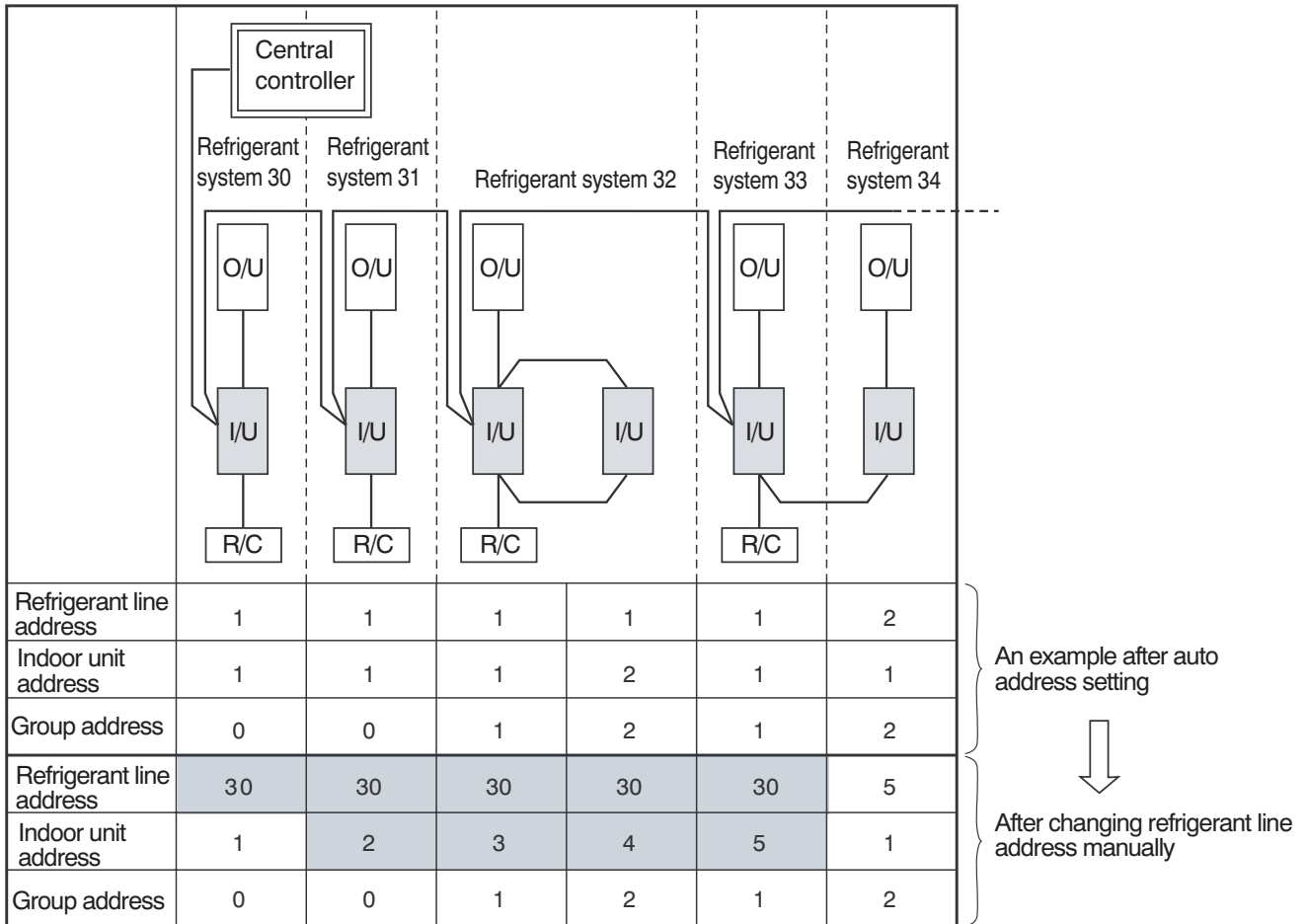

- * For changing/setting refrigerant line addresses by wired remote controller, refer to **11. ADDRESS SETTING.**
- * Change refrigerant line address of all indoor units connected directly to the central controller to “30”.
These indoor units are under twin or triple control, also change the refrigerant line address of follower indoor units to “30”.
- * Change indoor unit addresses so that they are not duplicated.

10-8-7. Central Control Address Number Setting

To connect an indoor unit to the central control remote controller, an address number for central control must be set.

- An address number for central control is indicated as the refrigerant line number of the remote controller.

1 Setting by Remote Controller on Indoor Unit Side

<Procedure> Perform the following steps in the operation OFF mode.

1 Push and on the remote controller simultaneously for 4 seconds or more.

When group control is going, UNIT No. *ALL* is displayed first, and all indoor units in the group are selected. At this time, the fans of all the selected indoor units start running. (Fig. 1)

Maintain this state without pushing .

For individual remote controllers without group control, a refrigerant line address and an indoor unit address are indicated.

2 Specify code *03* with buttons.

3 Choose setting data with buttons.

Table 1 shows setting data.

4 Push Indication on the LCD shows normal operation.

- To change an item for setting, return to **2**.

5 Push to return to the normal indication.

(Fig. 1)

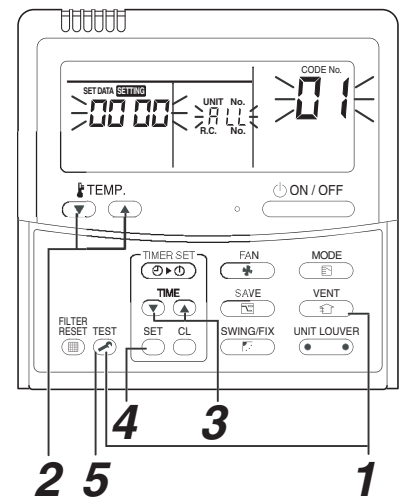

Table 1

Setting data	Address No. for central control
0001	1
0002	2
0003	3
0064	64
0099	Not set (factory setting)

11. ADDRESS SETTING

11-1. Address Setting

Address Setting Procedure

When twin or triple operation is selected with one indoor unit and one outdoor unit or when one outdoor is connected to each indoor unit even with multiple refrigerant systems in group operation, auto address setting is completed during the power on process of outdoor unit.

Remote controller operation is disabled during the auto address setting process (4 to 5 minutes).

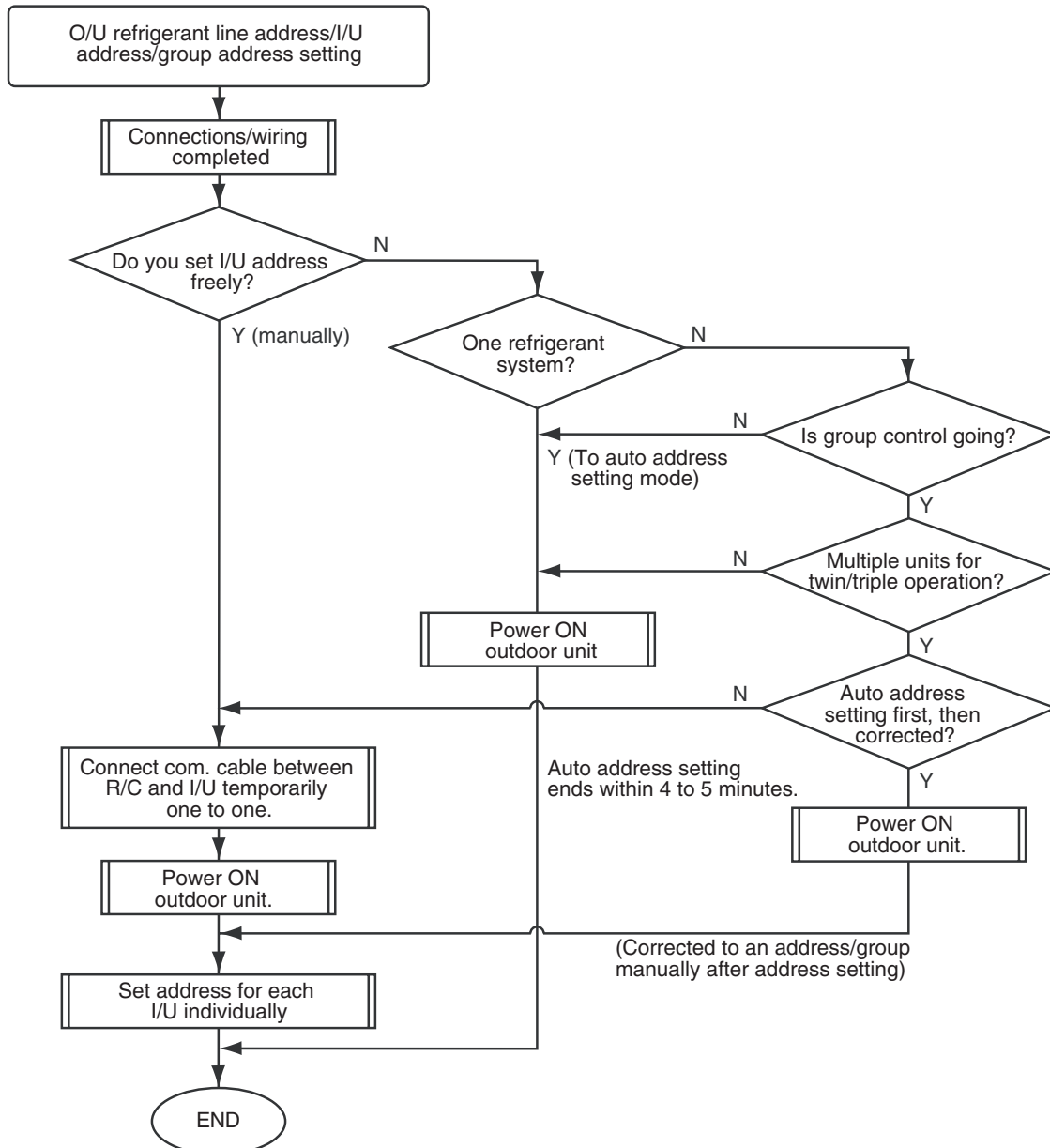

- Unless the following addresses are stored in the EEPROM (IC10) on the indoor unit board, trial operation is disabled. (Undefined data is stored at factory shipping.)

	Code	Factory setting data	Setting data range
Refrigerant line address	12	0099	0001 (unit No. 1) to 0030 (unit No. 30)
Indoor unit address	13	0099	0001 (unit No. 1) to 0064 (unit No. 64) Maximum I/U address in the same refrigerant system (double twin=4)
Group address	14	0099	0000 : Individual (indoor units without group control) 0001 : Header (one indoor unit in the group) 0002 : Follower (indoor units in the group except header unit)

11-2. Address Setting and Group/Twin/Triple Control

<Definition of terms>

- Indoor unit No. : N-n=O/U refrigerant line address N (30 max.) -I/U address n (64 max.)
- Group address : 0=Individual (without group control)
 1=Header unit under group control
 2=Follower units under group control
- Header indoor unit (=1) : A representative unit of multiple indoor units in group operation, which performs communication between remote controller and follower I/U.
 (* It does not mean an indoor unit that communicates with O/U.)
 Operation mode and setting temperature range (except louver air flow control) of header unit are reflected on the LCD of remote controller.
- Follower indoor unit (=2) : Indoor units except header unit in group operation.
 It does not control communication with remote controller in principle (except response to alarm/service data request).
- Main unit (Representative) (Twin header) : In a minimal configuration of refrigerant cycle such as twin, triple or double twin, an indoor unit which communicates with O/U among those with same refrigerant line address.
 Communicates with sub indoor units and with O/U (instructions to compressor) on behalf of cycle control.
- Sub indoor unit (Sub unit) (Twin follower) : Indoor units except the main indoor unit in a twin, triple or double twin system.
 Communicates with the main indoor unit with the same refrigerant line address, and provides control in synchronization with the main indoor unit.
 It does not communicate with O/U (no detection of serial signal alarm).

[1] System Configuration

a) Single

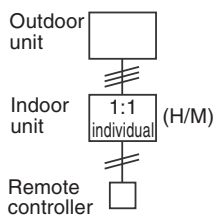

b) Twin, triple, double twin

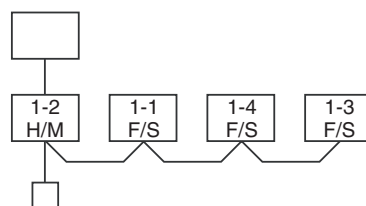

c) Single group operation

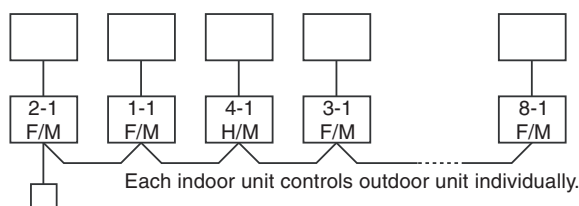

d) Multiple single/twin/triple group operation (manual address setting)

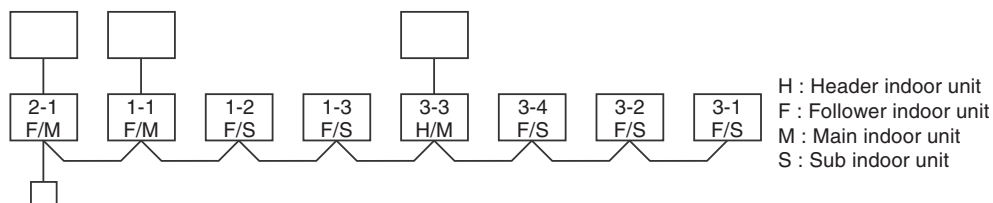

- Main indoor unit : Receives data (thermo status, etc.) from sub indoor units with same refrigerant line address, and controls O/U compressor referring to the self thermo status. Transmits this instruction to sub units.
- Sub indoor unit : Receives data from the main indoor unit with same refrigerant line address and serial interface with O/U, and performs thermo operation in synchronization with the main unit. Sends self thermo ON/OFF request to the main unit.

(Example) 1-1 main unit communicates with 1-2 and 1-3 sub units without being affected by indoor units with refrigerant line address 2 or 3.

[2] Examples of Aut Address Setting fro No Address Setting

1) Standard (one outdoor unit)

a) Single

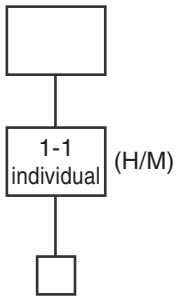

b) Twin

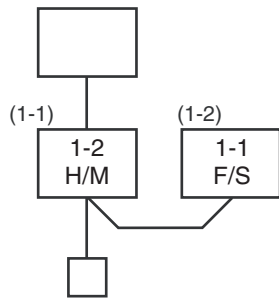

c) Double twin

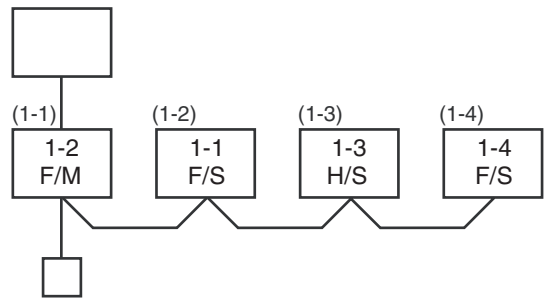

***** Turn ON the power. Address setting is completed automatically.*****

2) Group operation (multiple O/U = multiple indoor units with serial communication interface, no twin)

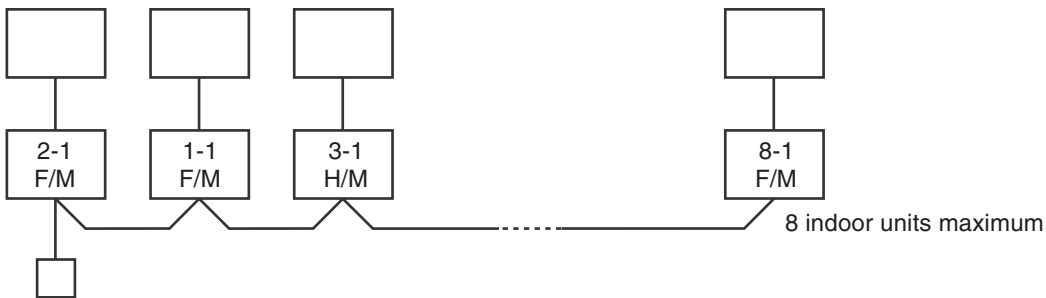

***** Turn ON the power. Address setting is completed automatically.*****

3) Multiple group operation

A (single)

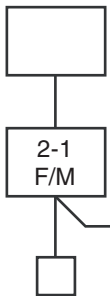

B (triple)

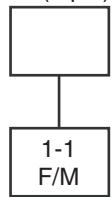

C (double twin)

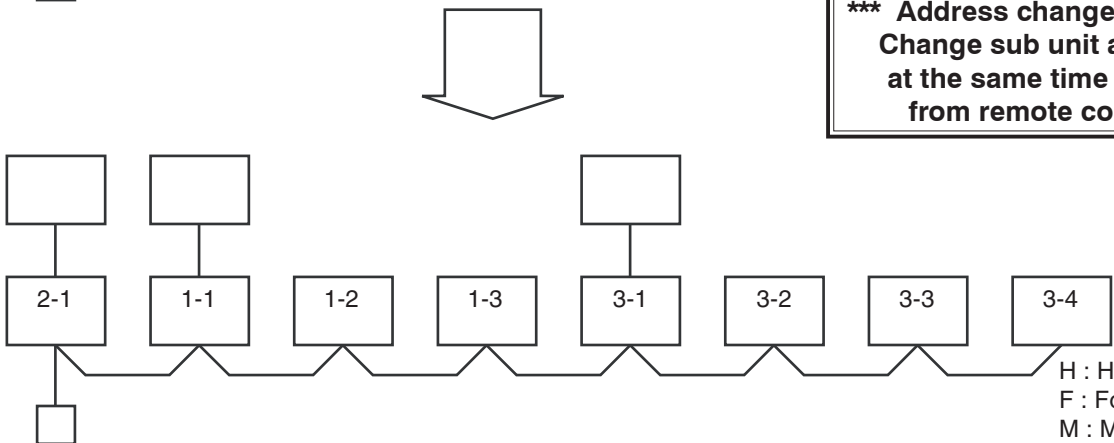
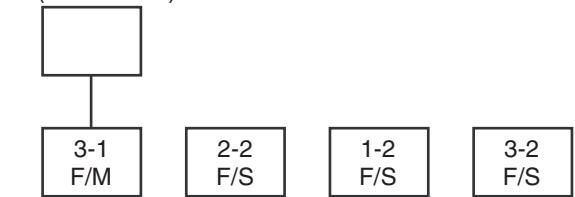

***** Address change required *****
Change sub unit addresses
at the same time manually
from remote controller.

H : Header indoor unit
 F : Follower indoor unit
 M : Main indoor unit
 S : Sub indoor unit

11-3. Address Setting

When determining indoor unit addresses with wiring completed without piping construction

Wiring example of 2 refrigerant systems
(Solid line: wiring, broken line: refrigerant piping)

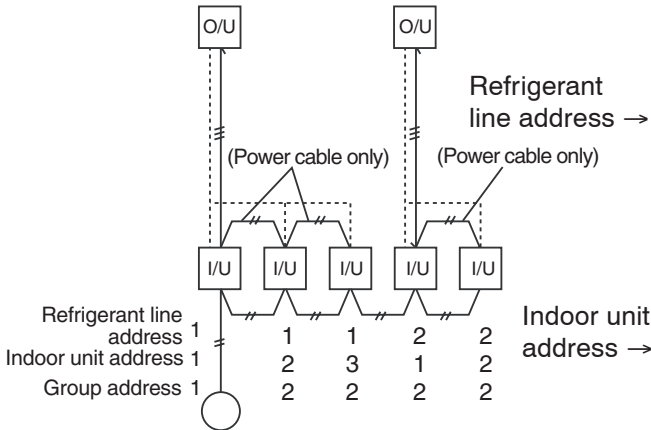

For systems like this example, connect a wired remote controller independently without connecting remote controller wires, and then set these addresses.

Group address
Individual: 0000
Header unit: 0001
Follower unit: 0002 } in case of group control

Group address →

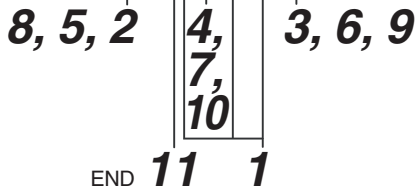
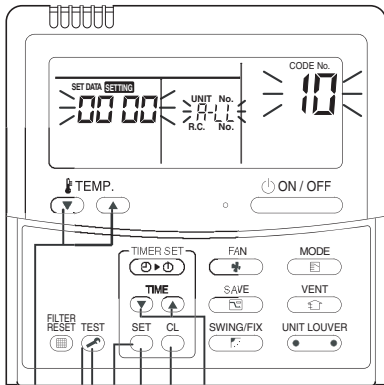

Operation procedure

1 → 2 → 3 → 4 → 5 → 6 → 7
8 → 9 → 10 → 11 END

(Manual setting by remote controller)

<Address setting procedure>

- Connect a remote controller to the indoor unit whose address you want to set one to one.
- Turn ON the power.

- 1 Push **TEST**, **SET**, and **CL** on the remote controller simultaneously for 4 seconds or more.
- 2 Set code **12** with **TEMP.** buttons.
- 3 Set a refrigerant line address with **TIME** buttons.
- 4 Push **SET** Indication on the LCD shows normal operation.
- 5 Set code **13** with **TEMP.** buttons.
- 6 Set indoor unit addresses with **TIME** buttons.
- 7 Push **SET** Indication on the LCD shows normal operation.
- 8 Set code **14** with **TEMP.** buttons.
- 9 Set indoor unit addresses with **TIME** buttons as follows:
Individual= **0000**, header unit= **0001**, follower unit= **0002**
- 10 Push **SET** Indication on the LCD shows normal operation.
- 11 Push **TEST**.
Indoor unit address setting is completed.
The operation mode returns to normal OFF.

■ **Checking location of indoor unit number**

(1) To find the address of indoor unit whose location is clear

In case of independent operation
 (1:1 connection of wired remote controller and indoor unit)
 Perform the procedure during operation of indoor unit.

<Procedure>

1 When the indoor unit is not working, push  on the remote controller.

2 Push  .
 UNIT No. /-/- appears on the LCD and disappears in several seconds.
 The displayed number shows the refrigerant line address and indoor unit address.



When other indoor units are connected to the same remote controller (group control), their unit numbers are displayed in order each time  is pushed.

(2) To find the location of indoor unit from its address

When checking indoor unit number in the group.
 Perform the procedure while the indoor unit is not working.
 This procedure stops operation of all indoor units in the group.

<Procedure>

Indoor unit numbers appear one by one and the fan and louver of the displayed unit run.

1 Push  and  on the remote controller simultaneously for 4 seconds or more.

- UNIT No. *ALL* appears.
- The fan and louver of all indoor units in the group run.

2 Each pushing of  on the remote controller displays unit numbers in the group sequentially.

- The header unit address appears first.
- The fan and louver of a selected indoor unit run.

3 Push  to finish the procedure. Operation of all the indoor units in the group turns OFF.

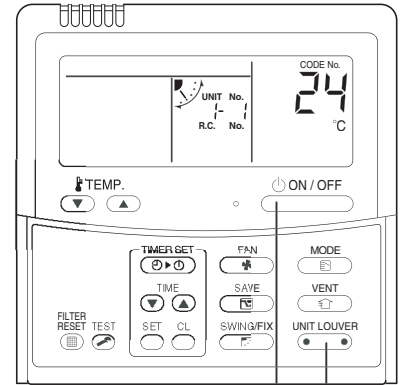

Operation procedure

1 → **2** **1** **2**

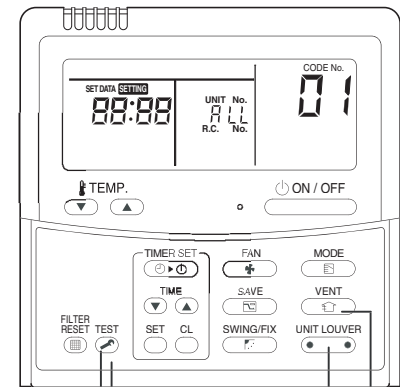

3
END

Operation procedure

1 → **2** → **3** END



12. DETACHMENTS

High Wall Type

RAV-SM566KRT-E(TR), RAV-SM806KRT-E(TR)

 **WARNING**

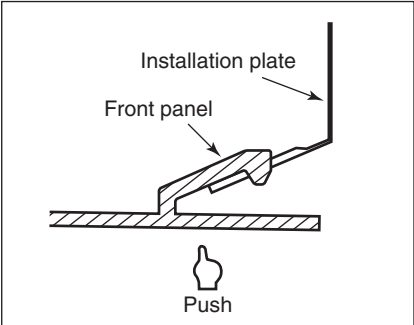
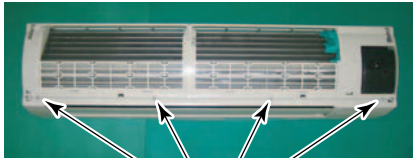
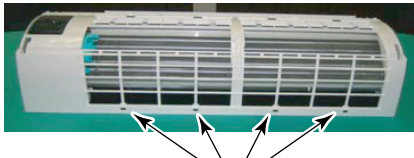
- Since high voltages pass through the electrical parts, turn off the power without fail before proceeding with the repairs. Electric shocks may occur if the main power supply switch or breakers are not turned off.
 - After the repairs have been completed (after the front panel and cabinet have been installed), perform a test run, and check for smoking, unusual sounds and other abnormalities.
If this check is omitted, a fire and/or electric shocks may occur.
Before proceeding with the test run, install the front panel and cabinet.
 - Ensure that the following steps are taken when doing repairs on the refrigerating cycle.
 1. Do not allow any naked flames in the surrounding area.
If a gas stove or other appliance is being used, extinguish the flames before proceeding.
If the flames are not extinguished, they may ignite any oil mixed with the refrigerant gas.
 2. Do not use welding equipment in an airtight room.
Carbon monoxide poisoning may result if the room is not properly ventilated.
 3. Do not bring welding equipment near flammable objects.
Flames from the equipment may cause the flammable objects to catch fire.
 - **If keeping the power on is absolutely unavoidable while doing a job such as inspecting the circuitry, wear rubber gloves to avoid contact with the live parts.**
Electric shocks may be received if the live parts are touched.
High-voltage circuits are contained inside this unit.
Proceed very carefully when conducting checks since directly touching the parts on the control circuit board may result in electric shocks.
-

No.	Part name	Procedures	Remarks
①	Front panel	<p>1) Stop operation of the air conditioner and turn off its main power supply.</p> <p>2) Open the air inlet grille, push the arm toward the outside, and remove the grille.</p> <p>3) Push "PUSH" part under the front panel and remove hooks of the front panel from the installation plate.</p> <p>4) Remove the front panel fixing screws. (4 pcs.)</p> <p>5) Take off 4 hooks of panel from rear side.</p> <p><How to assemble the front panel></p> <p>1) Push 3 center positions and 2 lower center positions of the air outlet, and then hang the hanging hooks (4 pcs.) at the top side of the front panel to the rear plate.</p> <p>2) Tighten four screws.</p> <ul style="list-style-type: none"> • Incomplete hanging or incomplete pushing may cause a dewdrops or generation of a fluttering sound. 	   <p>4 screws</p>  <p>4 hooks</p> 

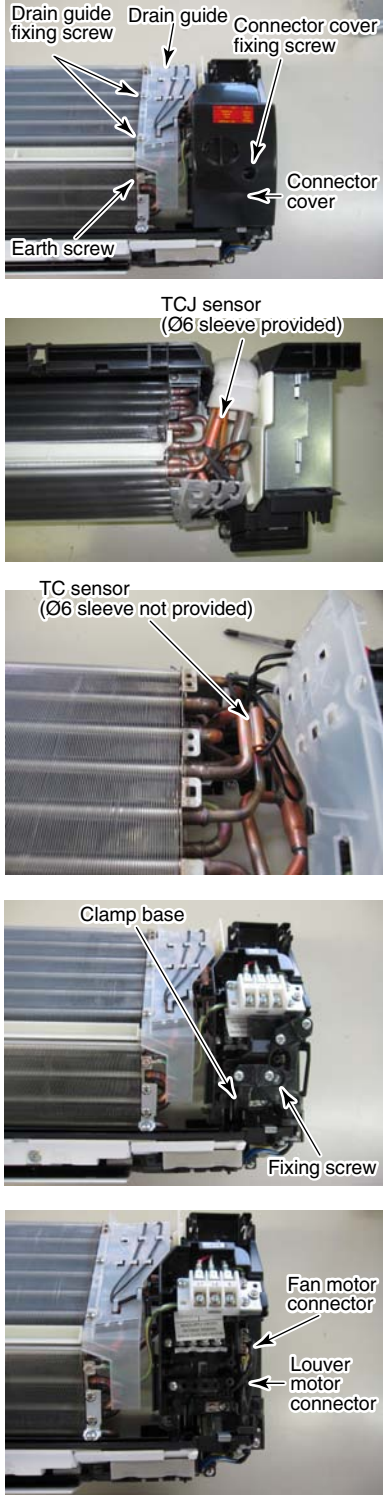
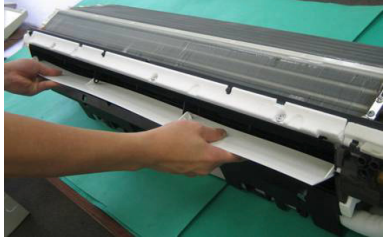
No.	Part name	Procedures	Remarks
②	Electric parts assembly	<ol style="list-style-type: none"> 1) Perform work of item ① . 2) Take off drain guide fixing screws (2pcs) 3) Pull out TC and TCJ sensors from the sensor holder of the heat exchanger. (When reassembling the elect parts ,be careful to the attaching positions of every sensor. TC and TCJ sensors resemble in the shapes , so distinct them by making ,etc. when mounting them.) 4) Take off the connentor cover mounting screw (1pc.) and then remove the connector cover. 5) Take off the clamp base mounting screw (1pc.) and then remove the clamp base. 6) Remove the fan motor connector (5P) and the connector for louver motor (5P) from the P.C. board. 7) Disengage the display unit by simply pushing at the top of the display unit. 8) Remove the fixing screw that secures the electrical parts box assembly, LED assembly and remove the assembly. 	 <p>Drain guide fixing screw Drain guide Connector cover fixing screw Earth screw Connector cover</p> <p>TCJ sensor (Ø6 sleeve provided)</p> <p>TC sensor (Ø6 sleeve not provided)</p> <p>Clamp base Fixing screw</p> <p>Fan motor connector Louver motor connector</p>
③	Horizontal louver	<ol style="list-style-type: none"> 1) Remove shaft of the horizontal louver from the back body. (First remove the left shaft, and then remove other shafts while sliding the horizontal louver leftward.) 	

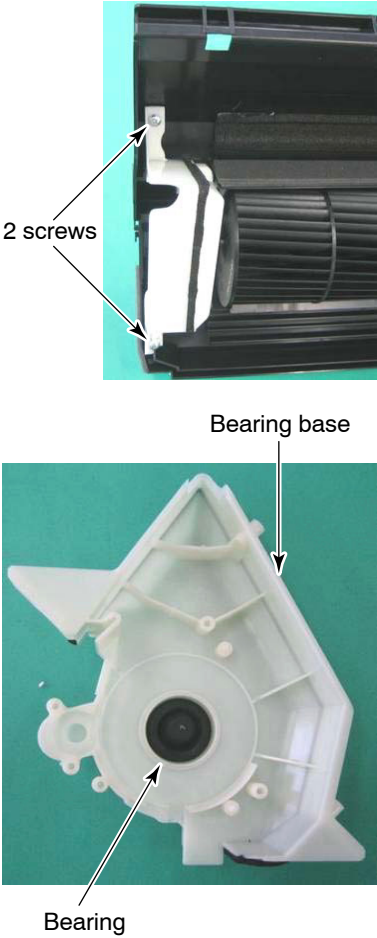
No.	Part name	Procedures	Remarks
⑤	Bearing	<p>1) Follow to the procedure in the item ④ .</p> <p>2) Remove the 2 screws used to secure the bearing base.</p> <p>3) Remove the bearing base.</p> <p><Caution at assembling></p> <ul style="list-style-type: none"> • If the bearing is out from the housing, push it into the specified position and then incorporate it in the main body. 	 <p>The top photograph shows a close-up of a white plastic housing with two screws being removed from the bearing base. The bottom photograph shows the bearing base and bearing being inserted into the housing.</p>

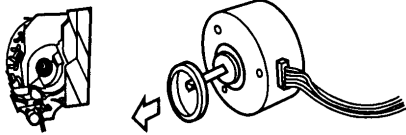
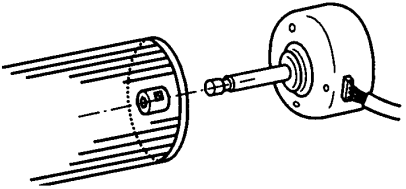
No.	Part name	Procedures	Remarks
⑦	Cross flow fan	<p><Caution at reassembling></p> <p>1) To incorporate the fan motor, remove the fan motor rubber (at shaft core side), incorporate the motor into the position in the following figure, and then install the fan motor.</p> <ul style="list-style-type: none"> • Install the cross flow fan so that the right end of the 1st joint from the right of the cross flow fan is set keeping 5 mm from wall of rear plate of the main unit. • Holding the set screw, install the cross flow fan so that U-groove of the fan motor comes to the mounting hole of the set screw. • Perform positioning of the fan motor as follows: • When assembling the fan motor, the fan motor must be installed in such a way that the fan motor leads will be taken out is positioned at the bottom front. • After assembling the 2 fixing screws of the motor band (right) into the main body, position the fan motor, insert it, and then secure the motor band (right) using the 2 fixing screws. 	 <p style="text-align: center;">5.0mm</p>  

13. EXPLODED VIEWS AND PARTS LIST

High Wall Type

Model: RAV-SM566KRT-E(TR), RAV-SM806KRT-E(TR)

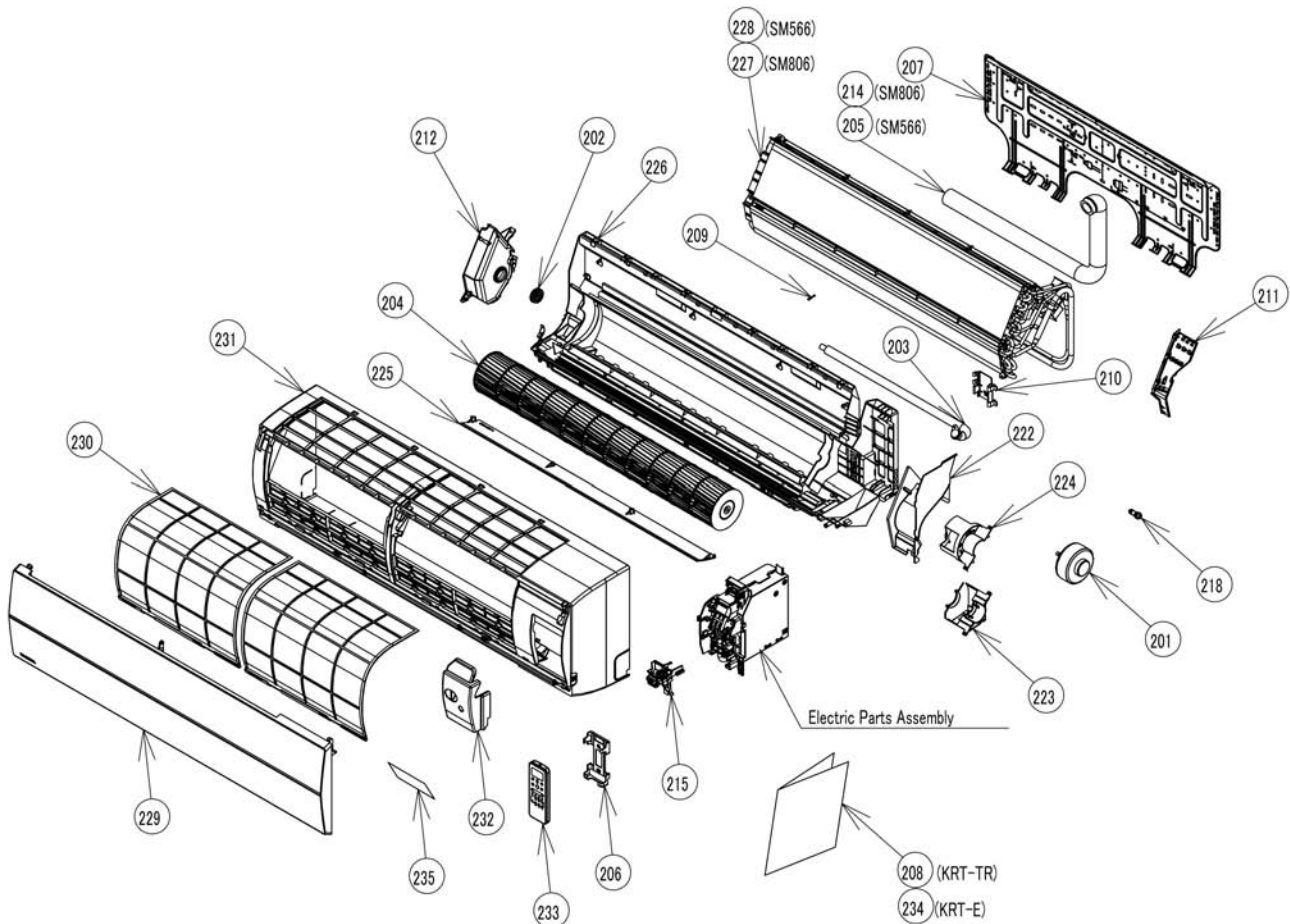

⚠ CAUTION

For orders of the service parts for High Wall type air conditioners, please check the service parts on Web site of [TOSHIBA CARRIER THAILAND CO., Ltd.], and then place an order for parts to (TOSHIBA CARRIER THAILAND CO., Ltd.).

Location No.	Part No.	Description	Location No.	Part No.	Description
201	43T21032	MOTOR, FAN	222	43T39026	BAND, MOTOR, LEFT
202	43T22312	BEARING ASSY, MOLD	223	43T39023	BAND, MOTOR, RIGHT DOWN
203	43T70313	HOSE, DRAIN	224	43T39022	BAND, MOTOR, RIGHT UP
204	43T20016	FAN, ASSY, CROSS FLOW	225	43T09040	LOUVER, HORIZONTAL
205	43T49010	PIPE, SHIELD (FOR RAV-SM566KRT-E,-TR)	226	43T03020	BODY, ASSY, BACK
206	43T83003	HOLDER, REMOTE CONTROL	227	43T44476	EVAPORATOR, ASSY (FOR RAV-SM806KRT-E,-TR)
207	43T82011	PLATE, INSTALLATION	228	43T44477	EVAPORATOR, ASSY (FOR RAV-SM566KRT-E,-TR)
208	43T85527	OWNER'S MANUAL (FOR RAV-SM566,806KRT-TR)	229	43T09439	GRILLE OF AIR INLET ASSY
209	43T19333	HOLDER, SENSOR	230	43T80019	AIR FILTER
210	43T49043	HOLDER, PIPE	231	43T00057	PANEL ASSY
211	43T39024	DRAIN GUIDE	232	43T62031	COVER, TERMINAL
212	43T22011	BEARING, BASE	233	43T66304	REMOCON-WRS
214	43T49045	PIPE, SHIELD (FOR RAV-SM806KRT-E,-TR)	234	43T85526	OWNER'S MANUAL (FOR RAV-SM566,806KRT-E)
215	43T62032	CLAMP BASE ASSY	235	43T15002	DISPLAY
218	43T79313	CAP, DRAIN			

Electric Parts

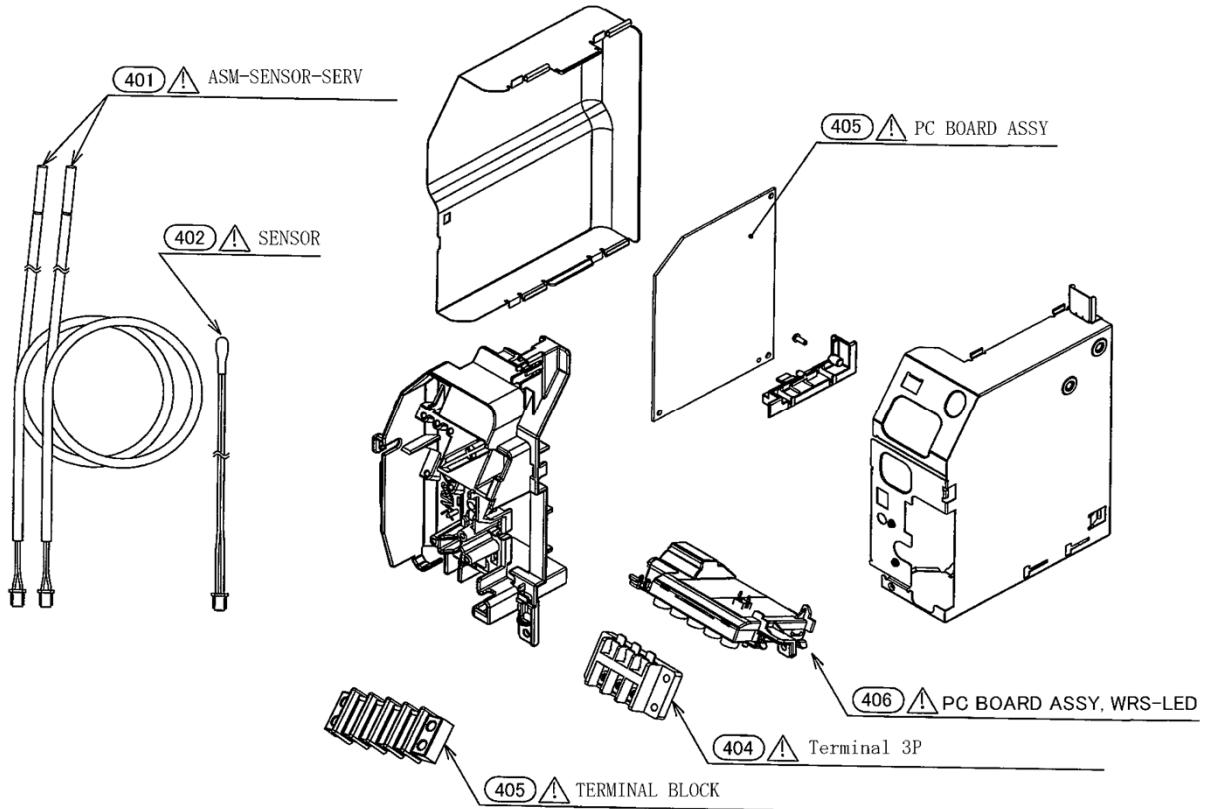

⚠ CAUTION

For orders of the service parts for High Wall type air conditioners, please check the service parts on Web site of [TOSHIBA CARRIER THAILAND CO., Ltd.], and then place an order for parts to (TOSHIBA CARRIER THAILAND CO., Ltd.).

Location No.	Part No.	Description	Location No.	Part No.	Description
401	43T50304	SENSOR;HEAT EXCHANGER	404	43T60079	TERMINAL BLOCK
402	43T69320	TEMPERATURE SENSOR	405	43T69979	PC BOARD ASSY
403	43T60047	TERMINAL	406	43T69084	PC BOARD ASSY, WRS-LED

14. Appendix

TOSHIBA

Leading Innovation >>>

Lite-Vision plus Remote Controller Installation Manual



Model name:

RBC-AMS51E-ES
RBC-AMS51E-EN





Contents

Precautions for Safety	2
Accessory Parts	3
Installation.....	4
Requirements to install the remote controller.....	4
Install the remote controller	6
Wire the remote controller.....	7
Requirements for wiring of group control.....	7
Requirements for installing two remote controllers.....	7
For first use.....	9
Note.....	9
Part Names and Functions	10
Monitor screen.....	11
Initial setting	12
1. Clock.....	12
2. Name of room.....	13
3. Screen contrast	14
4. Backlight.....	15
5. Key lock	15
6. Header/follower	16
7. Language	17
8. Press & hold 4sec.....	18
Field setting menu	19
1. Test Mode.....	19
2. Register service info	21
3. Alarm history	25
4. Monitor function.....	26
5. DN setting.....	27





- Read this manual before using the RBC-AMS51E-ES, RBC-AMS51E-EN remote controller.
- Refer to the Installation Manual supplied with the indoor unit for any installation instructions other than operations of the remote controller.

Precautions for Safety

- Read these "Precautions for Safety" carefully before installation.
- The precautions described below include important items regarding safety. Observe them without fail. Understand the following details (indications and symbols) before reading the body text, and follow the instructions.
- Ask customer to keep this Manual at accessible place for future reference.

Indication	Meaning of Indication
	WARNING Text set off in this manner indicates that failure to adhere to the directions in the warning could result in serious bodily harm (*1) or loss of life if the product is handled improperly.
	CAUTION Text set off in this manner indicates that failure to adhere to the directions in the caution could result in serious bodily injury (*2) or damage (*3) to property if the product is handled improperly. *1: Serious bodily harm indicates loss of eyesight, injury, burns, electric shock, bone fracture, poisoning, and other injuries which leave aftereffect and require hospitalization or long-term treatment as an outpatient. *2: Bodily injury indicates injury, burns, electric shock, and other injuries which do not require hospitalization or long-term treatment as an outpatient. *3: Damage to property indicates damages extending to buildings, household effects, domestic livestock, and pets.
Symbols	Meaning of Symbols
	"⊘" Indicates prohibited items. The actual contents of the prohibition are indicated by a picture or text placed inside or next to the graphic symbol.
	"ⓘ" Indicates compulsory (mandatory) items. The actual contents of the obligation indicated by a picture or text placed inside or next to the graphic symbol.
	WARNING <ul style="list-style-type: none"> • Only a qualified installer or service person is allowed to do installation work. Inappropriate installation may result in water leakage, electric shock or fire. • Perform installation work properly according to the Installation Manual. Inappropriate installation may result in water leakage, electric shock or fire. • Electrical work must be performed by a qualified electrician in accordance with this installation manual. The work must satisfy all local, national and international regulations. Inappropriate work may result in electric shock or fire. • Use predefined wire and connect them certainly. Keep the connecting terminal free from external force. Improper wire connection or clamping may result in exothermic, fire or malfunction. • The electrical work must satisfy all local, national and international regulations.

Accessory Parts

No.	Part name	Quantity
(1)	Remote controller 	1
(2)	Screws (small) M4 x 20 	2
(3)	Wood screws M3.8 x 16 	2
(4)	Owner's Manual 	1
(5)	Installation Manual (This manual) 	1
(6)	CD-ROM	1

Installation

■ Requirements to install the remote controller

- ◆ **Installation place**
 - Install the remote controller at a height of 1 to 1.5 m from the floor so that the average temperature in the room can be detected.
 - Do not install the remote controller in a place exposed to direct sunlight or direct outside air, such as the side of a window.
 - Do not install the remote controller in a place behind something or to the rear side of an object, where air flow is not sufficient.
 - Do not install the remote controller in a freezing box or refrigerator, as the remote controller is not waterproof.
 - Install the remote controller vertically to the wall.

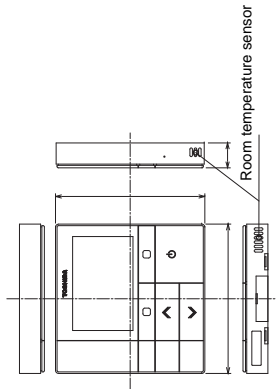

◆ Installation dimension

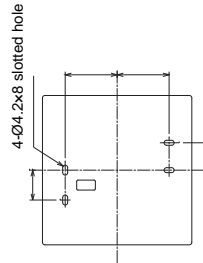

◆ Remote control wiring and inter-unit wiring between remote controllers

Do not allow the wire for the remote controller (communication wire) and the wire for AC220-240 V to come into contact or put them together in one electrical conduit; otherwise, the control system may have trouble due to noise. * Varies depending on the type of remote controller used.

Wiring type	VCTF: 0.5 mm ² to 2.0 mm ² x 2	
Total length of remote control wiring and inter-wiring between remote controllers (L+L1+L2+...Ln)	1 remote controller	2 remote controllers including a wireless remote controller
Total length of inter-wiring between remote controllers (L1+L2+...Ln)	Up to 500 m	Up to 300 m
	Up to 200 m	

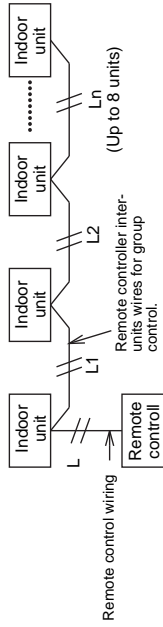

◆ Installation of multiple remote controllers

To install two or more adjacent remote controllers, follow the instructions in the Fig. 1 and 2.

(Fig. 1)

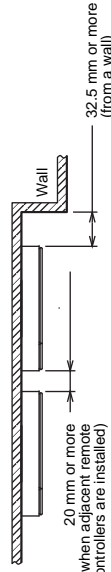

(Fig. 2)

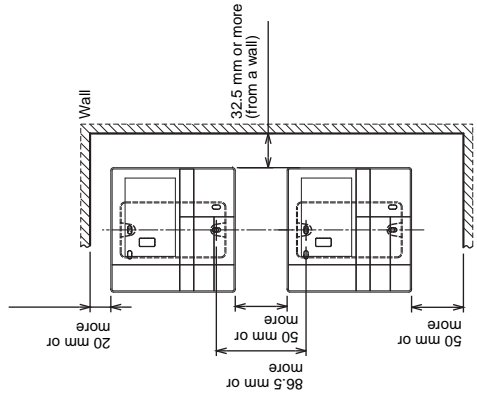

■ Install the remote controller

NOTE

- Wiring for the remote controller should not be bundled or installed in the same conduit with a power cable.; otherwise, malfunction may result.
- Install the remote controller away from sources of electrical interference and electromagnetic fields.

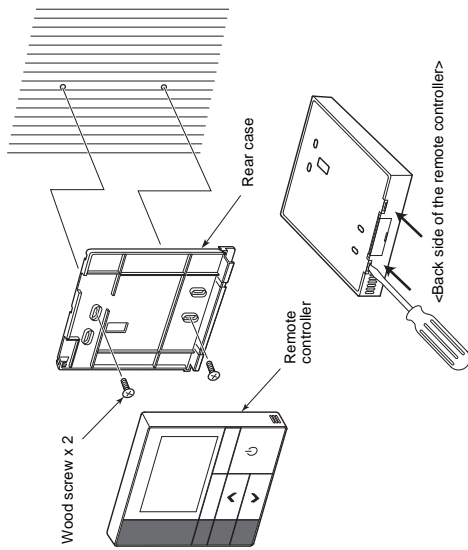

- 1 Insert a flat-blade screwdriver into the groove on the back side of the remote controller to remove the rear case.
- 2 Use the wood screws (2 pieces) supplied with the remote controller to attach the rear case of the remote controller to the wall. Do not use an electrical screwdriver. Do not over-tighten the screw (Tightening torque is up to 2 kg / fcm.); otherwise, the rear case may be damaged.
- 3 Connect the electrical wire from the indoor unit to the terminal block of remote controller. (Refer to "Wire the remote controller".)
Check the terminal number of electrical wire from the indoor unit to avoid miswiring. (If AC 200-240 V is applied, the remote controller and indoor unit will break down.)

■ Wire the remote controller

Wiring diagram

Terminal block for the remote control wiring on the indoor unit

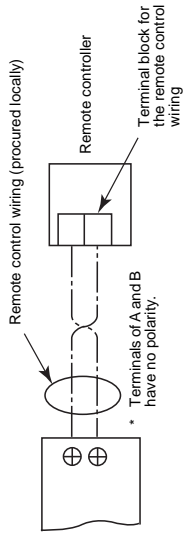

- * Use wire of 0.5 mm² to 2.0 mm².
- * A crimp-style terminal cannot be used.

■ Requirements for wiring of group control

- To make wiring of group control for indoor units of 4-way cassette type and other types, set the 4-way cassette type as the header unit; otherwise, some settings such as the individual louver setting are not available.
- To make wiring of group control for the indoor unit with the automatic grille-up / down function and the one without the function, set the indoor unit with the automatic grille-up / down function as the header unit; otherwise, the automatic grille-up / down function is not available.

■ Requirements for installing two remote controllers

In the dual remote controller system, one or more units are operated from two remote controllers. (Up to two remote controllers can be installed.)

Set the follower remote controller

Set from "6. Header/follower" in "10. Initial setting" on the MENU screen. For details, refer to the page 16.

Install the remote controllers

For the dual remote controller system, install the remote controllers as follows:

- 1 Set one remote controller as the header remote controller. (The remote controllers are set as "Header remote controller" as factory default.)
- 2 When the dual remote controller system is installed by using this remote controller (RBC-AMS51E-ES, RBC-AMS51E-EN) with the other type of remote controller, set this remote controller as the header remote controller.

Basic wiring diagram

NOTE

Terminals of A and B have no polarity.

To diverge from the indoor unit

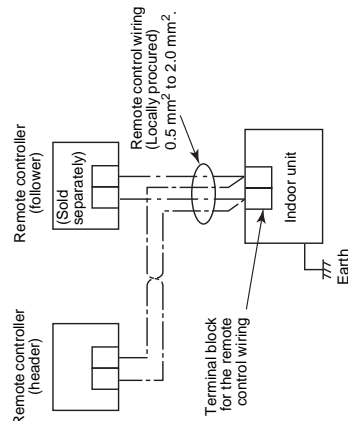

To diverge from the header remote controller

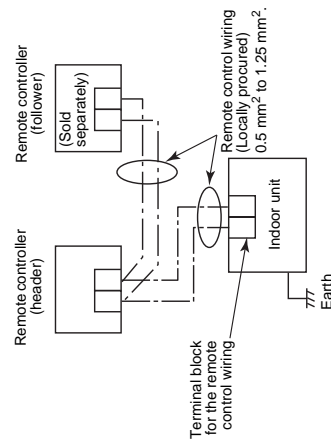

To operate a group control of multiple indoor units by two remote controllers

* The header or follower remote controller can be connected to any indoor unit.

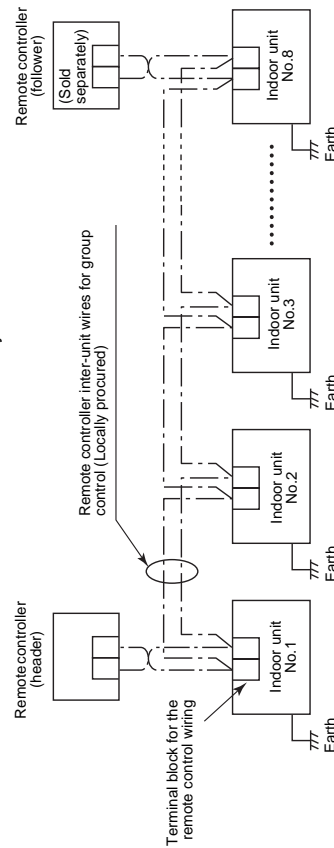

For first use

It takes some time before the remote controller becomes operable when the remote controller is used for the first time. This is not a malfunction.

<When the power is turned on for the first time after installation>

It takes about 5 minutes before the remote controller becomes operable.

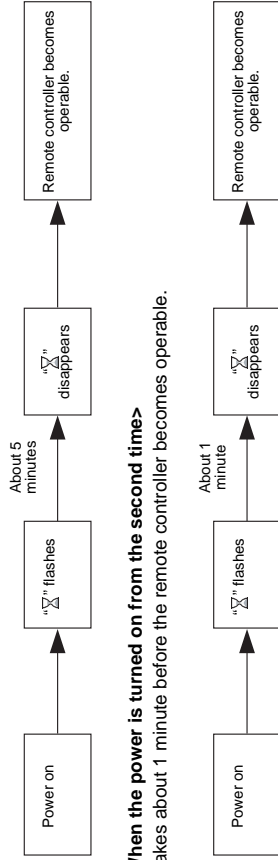

<When the power is turned on from the second time>

It takes about 1 minute before the remote controller becomes operable.

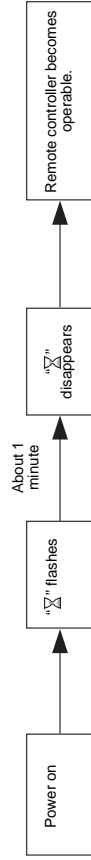

Note

For the operation of switching the room temperature sensor or the settings of the test operation, refer to the page 19.

Part Names and Functions

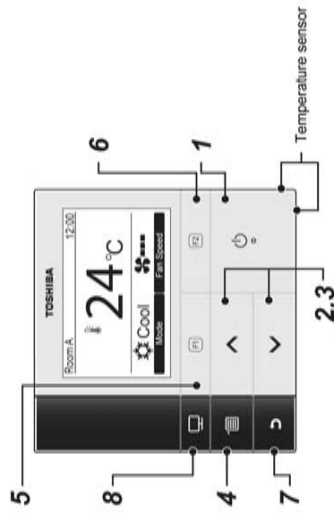

- 1 [] **ON / OFF** button
- 2 [] **▲** button
During normal operation: adjusts the temperature.
On the menu screen: selects a menu item.
- 3 [] **▼** button
During normal operation: adjusts the temperature.
On the menu screen: selects a menu item.
- 4 [] **MENU** button
Displays the menu screen.
- 5 [] **F1** button
Varies its function according to the setting screen.
- 6 [] **F2** button
Varies its function according to the setting screen.
- 7 [] **CANCEL** button
Functions as indicated on the screen, such as returning to the previous menu screen.
- 8 [] **MONITOR** button
Displays the monitoring screen.

Switching between the normal display and detailed display

Push and hold the [] **CANCEL** button and [] **MONITOR** button at the same time for more than 4 seconds to switch the display mode.
The normal display mode is selected as factory default setting.
Normal display mode (factory default)

Detailed display mode

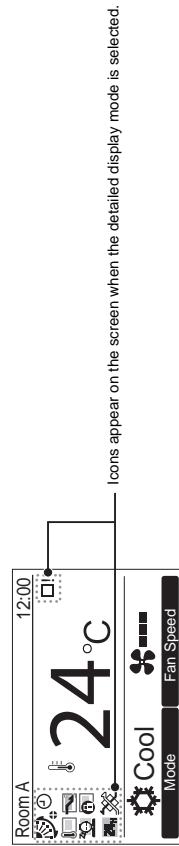

Monitor screen

Check the current usage status.

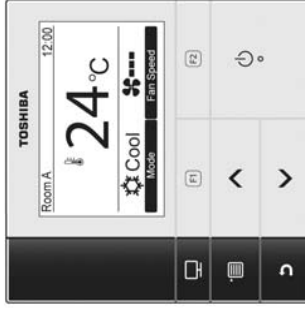

- 1 Push [] **MONITOR** button.
The monitor screen appears.
- 2 Push [] **CANCEL** button to return.

- (1) Displays the set temperature.
- (2) Displays the temperature measured by the indoor temperature sensor of the indoor unit.
If the sensor is set to that of the remote controller, the temperature measured by the remote controller sensor is displayed.
- (3) Displays the temperature around the vent of the outdoor unit.
- (4) Displays the remaining time until the filter sign lights up.
- (5) Displays the accumulated operating time.

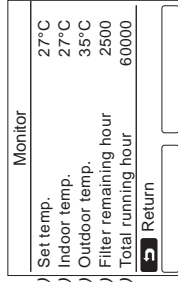

- (1) Set temp. 27°C
- (2) Indoor temp. 27°C
- (3) Outdoor temp. 35°C
- (4) Filter remaining hour 2500
- (5) Total running hour 60000

NOTE

Total running hour

- The Total running hour is recorded on the remote controller.
- The time is not recorded during Self cleaning operation or fan operation.

Outdoor temp.

- Displays the temperature around the vent of the outdoor unit.

- The displayed temperature may differ from the actual outdoor temperature.

Others

- The Header status appears during group connection.

Initial setting



- 1** Push the [MENU] button to display the menu screen.
- 2** Push the [^]/[v] button to select "1.Clock" on the menu screen, then push the [Set] button [F2].
- 3** Push the [^]/[v] button to select an item on the "Initial setting" screen.
- 4** Push the [Set] button [F2].
→ The selected menu setting screen will be displayed.
- 5** Push the [CANCEL] button to return.
→ The screen returns to the menu screen.

1. Clock

Set the year, month, date, and time.



- 1** Push the [^]/[v] button to select "1. Clock" on the "Initial setting" screen, then push the [Set] button [F2].
- 2** Push the [^]/[v] button to select the year, month, date, and time.
→ Push the [F2] button to set the value.
+ [F2] button to set the value.
- 3** Push the [MENU] button.

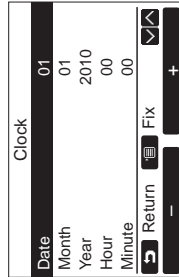

To adjust the clock

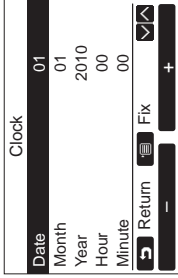

- 1** Push the [^]/[v] button to select "1. Clock" on the "Initial setting" screen, then push the [Set] button [F2].
- 2** Push the [^]/[v] button to select the year, month, date, and time.
→ Push the [F2] button to set the value.
+ [F2] button to set the value.
- 3** Push the [MENU] button.

The clock display appears on the upper right of the screen.

- The clock display blinks if the clock setting has been reset due to power failure or other cause.

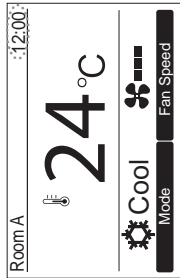

NOTE

The available date range is from January 1st, 2010 to December 31st, 2099.

2. Name of room

Set the name of the room or place where the remote controller is installed. (Operations of the air conditioner are possible without this setting.)

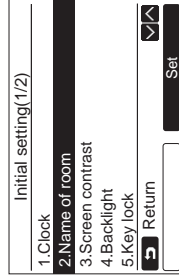

- 1** Push the [^]/[v] button to select "2. Name of room" on the "Initial setting" screen, then push the [Set] button [F2].
- 2** Set the name of the remote controller.

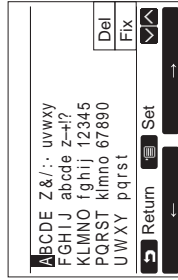

Enter the characters of the name in the screen (1).
Move the cursor to select the character with the [^]/[v] button and [F2] button (the selected character is highlighted) then push the [MENU] button.
Name of the remote controller appears.

Up to 16 characters can be entered for Name of room.

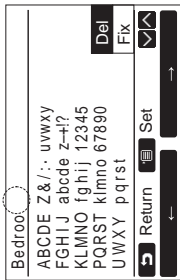

To delete a character, highlight "Del" and push [MENU] button.

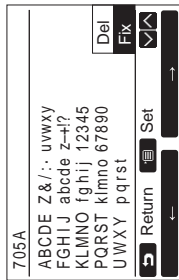

To confirm the name, highlight "Fix" and push [MENU] button.
→ The screen returns to the "Initial setting" screen.

3. Screen contrast

Adjust the contrast of the LCD.

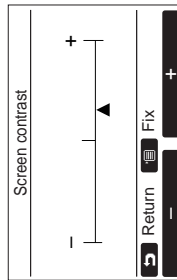
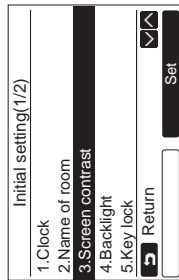

- 1 Push the [^]/[^]/[^]/[^] button to select "3. Screen contrast" on the "Initial setting" screen, then push the "Set" [F2] button.
- 2 Push the "—" [F1] / "+" button to adjust.
- 3 Push the [MENU] button.
→ The screen returns to the "Initial setting" screen.

4. Backlight

Turn on or off the back light of the LCD.

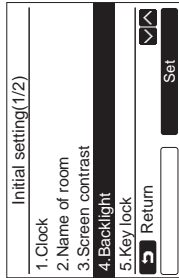

1 Push the [^]/[^]/[^]/[^] button to select "4. Backlight" on the "Initial setting" screen, then push the "Set" [F2] button.

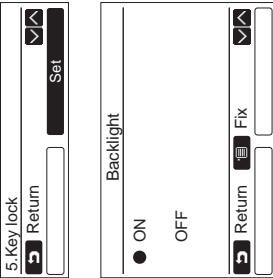

2 Push the [^]/[^]/[^]/[^] button to select "ON" or "OFF".

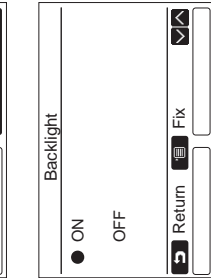

3 Push the [MENU] button.
→ When "ON" is selected, the back light is turned on during operating with the remote controller.
→ When "OFF" is selected, the back light is not turned on.

NOTE

The back light of the LCD is turned on as factory default.

5. Key lock

Select whether to lock / unlock [ON / OFF], [MODE(F1)], [MODE(F1) and [FAN SPEED(F2)].

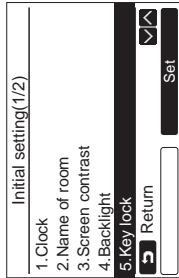

1 Push the [^]/[^]/[^]/[^] button to select "5. Key lock" on the "Initial setting" screen, then push the "Set" [F2] button.

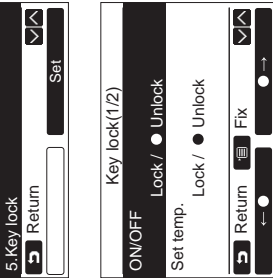

2 Push the [^]/[^]/[^]/[^] button to select a key to lock / unlock.

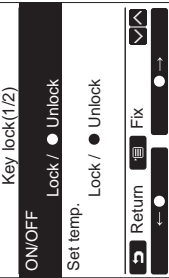

3 Push the "←" [F1] button to select "Lock", or "→" [F2] button to select "Unlock".

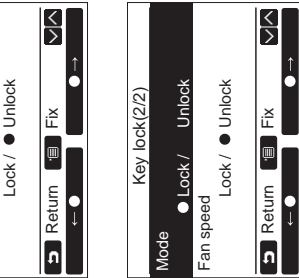

4 Push the [MENU] button.
→ When "Lock" is selected, the key cannot be used during key lock.
When "Unlock" is selected, the key can be used even during key lock.
→ All keys are unlocked while "Check" is displayed.
→ For the key lock setting, refer to the owner's manual.
→ The factory default is "Lock".

6. Header/follower

Set the remote controller as "Header remote controller" or "Follower remote controller" when the dual remote controller system is used.
 Carry out the setting operation while the indoor unit is stopped. (Turn off the air conditioning unit before starting the setting operation.)

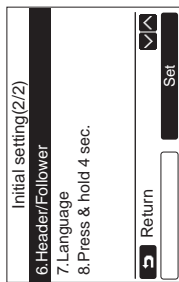

- 1 Push the [^]/[\]/[v]/[>] button to select "6. Header/follower" on the "Initial setting" screen, then push the "Set" [Set] [F2] button.
- 2 Push the [^]/[\]/[v]/[>] button to select the setting.
- 3 Push the [MENU] button.
 → "Setting" appears on the screen, then the screen returns to the "Initial setting" screen.

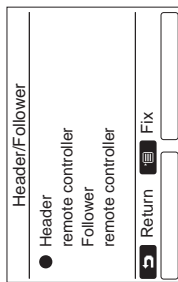

Note for the Header/follower setting

- Set the RBC-AMS51E-ES and RBC-AMS51E-EN remote controller as the Header remote controller when the dual remote controller system is used.
- The RBC-AMS51E-ES and RBC-AMS51E-EN remote controller can be used as the Follower remote controller when the dual remote controller system is used that consists of two RBC-AMS51E-ES, RBC-AMS51E-EN remote controllers.
- The following functions are not available when the remote controller is set as the Follower remote controller: Schedule timer / Off reminder timer / Night operation / Save operation / Return back

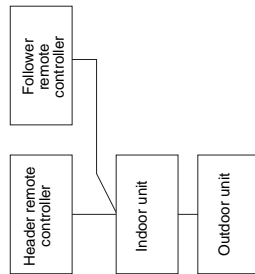

NOTE

- Some functions are not available when the remote controller is set as the Follower remote controller.
- In the dual remote controller system, the latter operation overrides the former.
- The remote controller is set as "Header remote controller" as factory default.

7. Language

Select a language for the screen text.

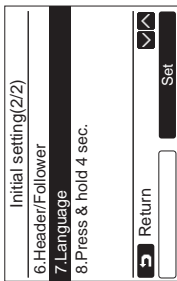

- 1 Push the [^]/[\]/[v]/[>] button to select "7. Language" on the "Initial setting" screen, then push the "Set" [Set] [F2] button.
- 2 Push the [^]/[\]/[v]/[>] button to select a language.
- 3 Push the [MENU] button.
 The screen text changes to the selected language.
 → The factory default is English.

These two screens appear for RBC-AMS51E-ES.

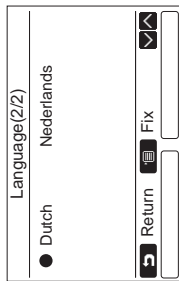
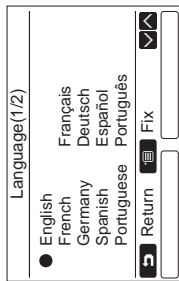

These two screens appear for RBC-AMS51E-EN.

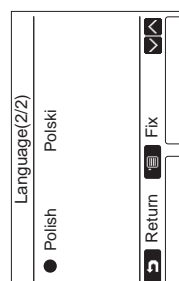
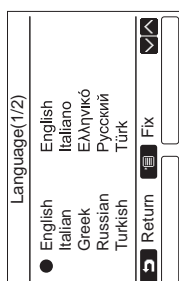

8. Press & hold 4sec.

Set the "press and hold" operation for the [ON / OFF] button.

- 1 Push the [^]/[v] button to select "8. Press & hold 4sec." on the "Initial setting" screen, then push the "Set" [] button.
- 2 Push the [^]/[v] button to select "ON" or "OFF".
- 3 Push the [] button.
 → When "ON" is selected, the air-conditioner starts / stops running when the [ON / OFF] button is pressed and hold 4 seconds.
 → When "OFF" is selected, the air-conditioner starts / stops running when the [ON / OFF] button is pressed.

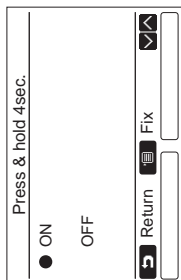
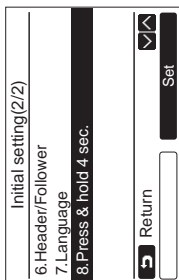

Field setting menu



- 1 Push the [] button to display the menu screen.
- 2 Push and hold the [] button and the [v] button at the same time to display the "Field setting menu".
 → Push and hold the buttons for more than 4 seconds.
- 3 Push the [] button to return.

Item	Function
1. Test mode	Settings for when performing the test operation after installation
2. Register service info	Registration of information about the contact number for service, model name and serial number of the indoor unit and outdoor unit
3. Alarm history	List of latest 10 alarm data: error information of check code, date, time, and unit factor.
4. Monitor function	Monitoring data of sensor temperature, rotating speed of the compressor or other factor.
5. DN setting	Advanced settings using DN code

1. Test Mode

Set for the test operation after installation.

Before the test mode

- Perform the followings before turning on the power:
 - 1) By using 500 V-megger, check that resistance of 1 MΩ or more exists between the terminal block of the power supply and the earth (earthing).
 If resistance of less than 1 MΩ is detected, do not run the unit.
 - 2) Check all valve of the outdoor unit is opened fully.
- To protect the compressor at the time of startup, leave the power on for 12 hours or more before operation.
- Do not press the electromagnetic contactor to forcibly perform the test mode. (It is very dangerous because the protective device does not work.)

Performing the test mode

For the procedure of the operation, refer to the supplied Owner's Manual. A forced test mode can be performed according to the following procedure when the room temperature rises / falls enough for the thermostat to turn off. In order to prevent a continuous operation, the forced test operation is released after 60 minutes have passed and it returns to the normal operation.

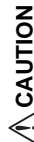

CAUTION

Do not perform the forced test mode for purposes other than the test mode because it applies an excessive load to the devices.

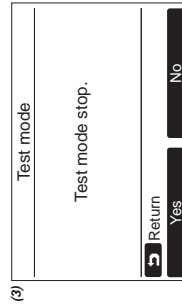
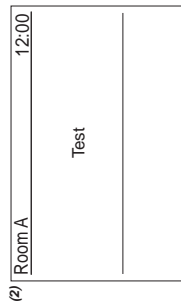
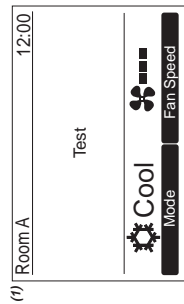
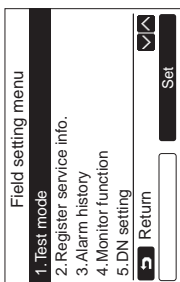

- 1** Push the [^] / [v] button to select "1. Test Mode" on the "Field setting menu" screen, then push the "Set" button [F2] button.

→ Pushing the "Yes" [F1] button sets the test mode and the screen returns to the field setting menu screen.
 Push [CANCEL] twice, the screen (2) appears.

- 2** Push the [ON / OFF] button to start the test mode. The screen (1) shown in the left appears. (The screen (2) appears when the operation is stopped.)

→ Perform the test mode in the "Cool" or "Heat" mode.
 → Temperature setting cannot be adjusted during the test mode.
 → Check codes are displayed as usual.

- 3** When the test mode is finished, push the [^] / [v] button to select "1. Test Mode" on the "Field setting menu" screen, then push the "Set" button [F2] button. The screen (3) appears.

→ Pushing the "Yes" [F1] button stops the test mode screen and continues the normal operation.

NOTE

The test mode stops after 60 minutes and the screen returns to the normal / detailed display.

Using the Service monitor with the [MONITOR] button during the test mode

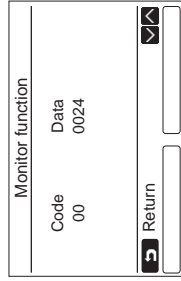
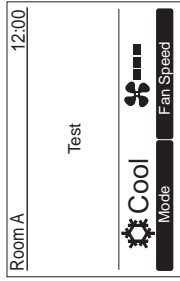

Push the [MONITOR] button

Refer to "4. Monitor function" (page 26) for details.

When the group control is used, select the unit to monitor in the unit selection screen before displaying the monitoring display.

2. Register service info

Register information about the contact number for service, model name and serial number of the indoor unit and outdoor unit.

- Enter information manually for a Light commercial outdoor unit.
 Information data of Light commercial indoor unit, multi indoor unit, and VRF outdoor unit is loaded automatically. Automatic loading is not available for some models. In this case, enter information manually.
- Enter the contact number for service displayed in "2. Service information" of "1. information" on the menu screen.
- Enter the model name and serial number displayed in "1. Model information" of "1. information" on the menu screen.

Entering information manually

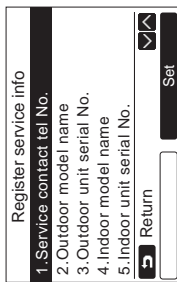

- 1** Push the [^]/[\]/[v]/[>] button to select "2. Register service info" on the field setting menu screen.
- 2** Push the " [Set] " button [F2] button. → The setting screen for entering information appears.
- 3** Enter the information with the " [F1]/[←]/[→]/[F2] button and [^]/[\]/[v]/[>] button.

Item	Function
1. Service contact tel No.	Enter the contact number for service.
2. Outdoor model name	Enter / reset the model name of the outdoor unit.
3. Outdoor unit serial No.	Enter / reset the serial number of the outdoor unit.
4. Indoor model name	Enter / reset the model name of the indoor unit.
5. Indoor unit serial No.	Enter / reset the serial number of the indoor unit.

Entering the contact number for service

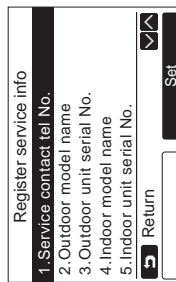

- 1** Push the [^]/[\]/[v]/[>] button to select "1. Service contact tel No.", then push the " [Set] " button [F2] button.

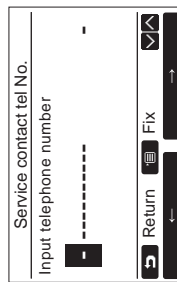

- 2** Move the cursor to select the character (selected character is highlighted) with the " [F1]/[←]/[→]/[F1]/[←]/[→]" button, then enter the contact number with the [^]/[\]/[v]/[>] button.
- 3** Push the [MENU] button.

Entering the model name and serial number

Enter the model name and serial number manually for a Light commercial outdoor unit. Information data is loaded automatically for Light commercial indoor units, VRF indoor units (excluding large capacity air discharge type and duct type), and VRF outdoor units. Enter the model name and serial number manually after replacing the circuit board to the service circuit board (unless entering information manually before replacement of the circuit board).

Product	Model name and serial number display
Light commercial indoor unit	Information data is loaded automatically from the indoor unit and displayed.
VRF indoor unit	Information data is loaded automatically from the indoor unit and displayed. Enter information manually for the indoor unit of large capacity air discharge type and duct type.
VRF outdoor unit	Information data is loaded automatically from the outdoor unit and displayed.
Light commercial outdoor unit	Enter information manually on the remote controller.
Service circuit board	Enter information manually on the remote controller.

<Flow chart of usual process>

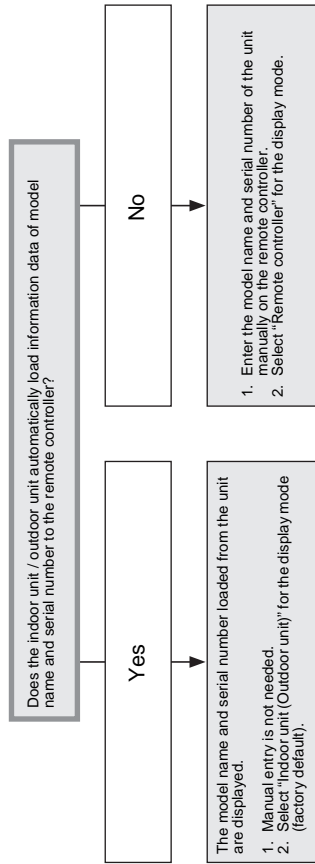

Entering the model name and serial number manually

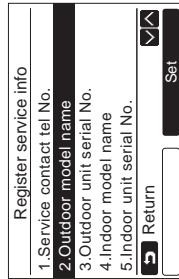

- 1** Push the [^]/[\]/[v]/[>] button to select "2. Outdoor model name" on the "Register service info" screen, then push the " [Set] " button [F2] button.
 - Select "3. Outdoor unit serial No." to enter the serial number of the outdoor unit.
 - Select "4. Indoor model name" to enter the model name of the indoor unit.
 - Select "5. Indoor unit serial No." to enter the serial number of the indoor unit.

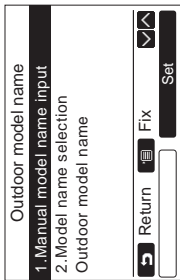

- Push the [^]/[\]/[v]/[>] button to select "1. Manual model name input" on the "Outdoor model name" screen, then push the "Set" button.
 - Select "1. Manual serial No. input" to enter the serial number of the outdoor unit.
 - Select "1. Manual model name input" to enter the model name of the indoor unit.
 - Select "1. Manual serial No. input" to enter the serial number of the indoor unit.

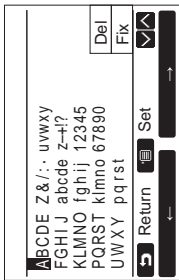

- Enter the model name of the outdoor unit.
 - See page 13 about how to enter the model name and serial number.

- Select "Remote controller" for the display mode of model name or serial number to display the manually entered model name or serial number. (See page 13.)

Selecting the model name and serial No.

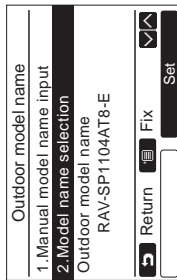

- Push the [^]/[\]/[v]/[>] button to select "2. Model name selection" on the "Outdoor model name" screen, then push the "Set" button.
 - To select the serial number of the outdoor unit, select "2. Serial No. selection".
 - To select the model name of the indoor unit, select "2. Model name selection".
 - To select the serial number of the indoor unit, select "2. Serial No. selection".

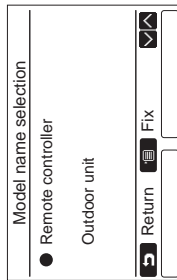

- Push the [^]/[\]/[v]/[>] button to select "Remote controller" or "Outdoor unit".
 - When "Outdoor unit" or "Indoor unit" is selected, the model name or serial number received from the outdoor or indoor unit is displayed.
 - When "Remote controller" is selected, the manually entered model name or serial number is displayed.
 - The factory default is "Outdoor unit" or "Indoor unit".

- Push the [MENU] button.
 - The screen returns to the "Outdoor model name" screen.

Checking the model name or serial number

The model name or serial number to be displayed on the Outdoor (Indoor) model name or Outdoor (Indoor) unit serial No. screen is displayed.

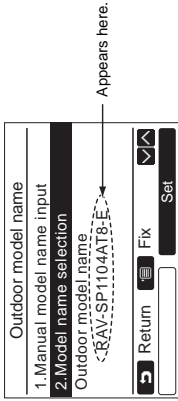

3. Alarm history

List of latest 10 alarm data: error information of check code, date, time, and unit, is displayed.

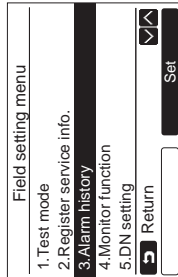

- Push the [^]/[\]/[v]/[>] button to select "3. Alarm history" on the "Field setting menu" screen, then push the "Set" button.
 - * The oldest data are deleted in order to record the new ones.
 - The date and time when the error occurred for the first time is displayed for the repeated alarm.

List of latest 10 Alarm data is displayed.

* The oldest data are deleted in order to record the new ones.

→ The date and time when the error occurred for the first time is displayed for the repeated alarm.

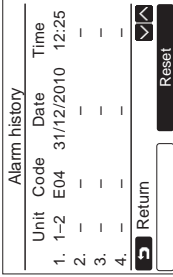

Deleting the alarm history

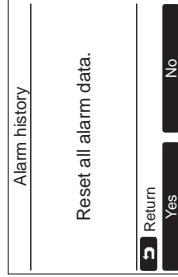

- Push the "Reset" button while the list of alarm history is displayed.

- Push the "Yes" button after the confirmation screen is displayed.

→ Delete the alarm history in each remote controller when the dual remote controller system is used.

4. Monitor function

The sensor temperature or operational status of indoor unit, outdoor unit, or remote controller can be monitored.

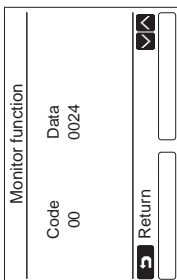

- 1 Push the [^]/[\]/[v]/[>] button to select "4. Monitor function" on the "Field setting menu" screen, then push the [Set] [F2] button.
→ Push the [^]/[\]/[v]/[>] button to select the code to check data.
- 2 Refer to the Installation Manual supplied with the indoor unit or outdoor unit or service manual for details about the check code and data.
- 3 Push the [CANCEL] button to return to the "Field setting menu" screen.

5. DN setting

Perform the advanced settings for the air conditioner. Carry out the setting operation while the indoor unit is stopped. (Turn off the air conditioning unit before starting the setting operation.)

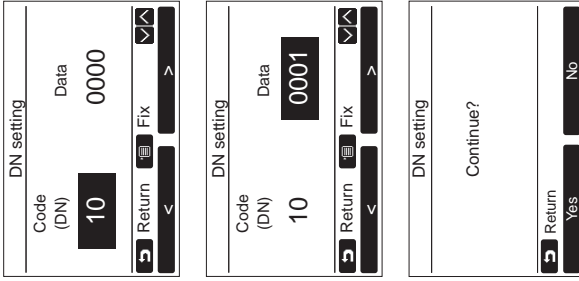

- 1 Push the [^]/[\]/[v]/[>] button to select "5. DN setting" on the "Field setting menu" screen, then push the [Set] [F2] button.
→ The fan and lower of the indoor unit operate. When the group control is used, the fan and lower of the selected indoor unit operate.
→ Move the cursor to select "DN code" with the " " < [F1] button, then set "DN code" with the [^]/[\]/[v]/[>] button.
→ Move the cursor to select "data" with the " " > [F2] button, then set "data" with the [^]/[\]/[v]/[>] button.
- 2 Refer to the Installation Manual supplied with the indoor unit or service manual for details about the DN code and data.
- 3 Push the [MENU] button to set the other DN codes. After "Continue?" is displayed on the screen, push the [Yes] [F1] button.
- 4 Push the [No] [F2] button to finish the setting operation. " " appears on the screen for a while, then the screen returns to the "Field setting menu" screen.
→ Pushing the [No] [F2] button displays the unit selection screen when the group control is used. Push the [CANCEL] button on the unit selection screen to finish the setting operation. " " appears on the screen for a while, then the screen returns to the "Field setting menu" screen.

WARNINGS ON REFRIGERANT LEAKAGE

Important

Check of Concentration Limit

The room in which the air conditioner is to be installed requires a design that in the event of refrigerant gas leaking out, its concentration will not exceed a set limit.

The refrigerant R410A which is used in the air conditioner is safe, without the toxicity or combustibility of ammonia, and is not restricted by laws to be imposed which protect the ozone layer. However, since it contains more than air, it poses the risk of suffocation if its concentration should rise excessively. Suffocation from leakage of R410A is almost non-existent. With the recent increase in the number of high concentration buildings, however, the installation of multi air conditioner systems is on the increase because of the need for effective use of floor space, individual control, energy conservation by curtailing heat and carrying power etc.

Most importantly, the multi air conditioner system is able to replenish a large amount of refrigerant compared with conventional individual air conditioners. If a single unit of the multi conditioner system is to be installed in a small room, select a suitable model and installation procedure so that if the refrigerant accidentally leaks out, its concentration does not reach the limit (and in the event of an emergency, measures can be made before injury can occur).

In a room where the concentration may exceed the limit, create an opening with adjacent rooms, or install mechanical ventilation combined with a gas leak detection device.

The concentration is as given below.

$$\frac{\text{Total amount of refrigerant (kg)}}{\text{Min. volume of the indoor unit installed (m}^3\text{)}} \leq \text{Concentration limit (kg/m}^3\text{)}$$

The concentration limit of R410A which is used in multi air conditioners is 0.3kg/m³.

NOTE 1 :

If there are 2 or more refrigerating systems in a single refrigerating device, the amounts of refrigerant should be as charged in each independent device.

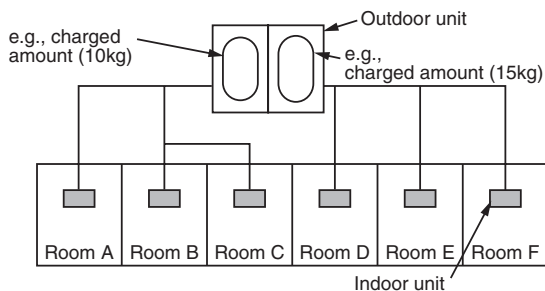

For the amount of charge in this example:

The possible amount of leaked refrigerant gas in rooms A, B and C is 10kg.

The possible amount of leaked refrigerant gas in rooms D, E and F is 15kg.

NOTE 2 :

The standards for minimum room volume are as follows.

- 1) No partition (shaded portion)

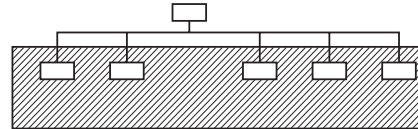

- 2) When there is an effective opening with the adjacent room for ventilation of leaking refrigerant gas (opening without a door, or an opening 0.15% or larger than the respective floor spaces at the top or bottom of the door).

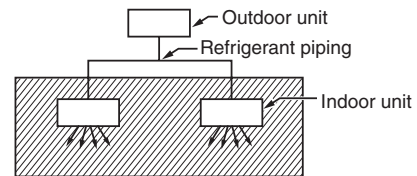

- 3) If an indoor unit is installed in each partitioned room and the refrigerant piping is interconnected, the smallest room of course becomes the object. But when a mechanical ventilation is installed interlocked with a gas leakage detector in the smallest room where the density limit is exceeded, the volume of the next smallest room becomes the object.

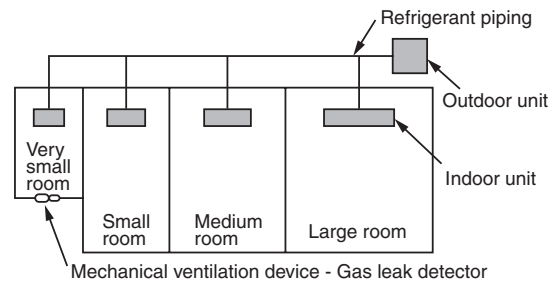

NOTE 3 :

The minimum indoor floor area compared with the amount of refrigerant is roughly as follows: (When the ceiling is 2.7m high)

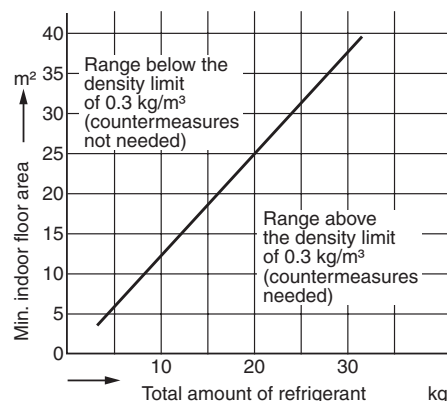

TOSHIBA CARRIER CORPORATION